



(BID SET)

**HILLSBOROUGH COUNTY
AVIATION AUTHORITY**

PROJECT MANUAL

(Containing Bidding and Contract Requirements, and Specifications)

FOR

PERIMETER FENCE REHABILITATION

AUTHORITY PROJECT NUMBER 6440 17

**PETER O. KNIGHT AND PLANT CITY AIRPORTS
TAMPA, FLORIDA**

Prepared By: Procurement Department

SOLICITATION NUMBER: 17-411-013

ISSUE DATE: May 8, 2017

DIVISION 0

BIDDING AND CONTRACT REQUIREMENTS

TABLE OF CONTENTS

PERIMETER FENCE REHABILITATION

Authority Project No. 6440 17

PETER O. KNIGHT AND PLANT CITY AIRPORTS
Tampa, Florida

SECTION	TITLE	PAGES
DIVISION 0 -BIDDING AND CONTRACT REQUIREMENTS		
00020	INVITATION TO BID	1 - 3
00100	INSTRUCTIONS TO BIDDERS.....	1 - 17
00300	BID FORM.....	1 - 6
00340	BID SCHEDULE.....	1 - 2
00350	BID AFFIDAVIT	1
00400-1	BID BOND	1
00400-2	SURETY BOND AFFIDAVIT	1
00417	WOMAN AND MINORITY OWNED BUSINESS ENTERPRISE ASSURANCE AND PARTICIPATION	1 - 4
00418	CERTIFICATE OF NON-SEGREGATED FACILITIES.....	1
00420	BIDDER'S GENERAL BUSINESS INFORMATION	1 - 6
00421	SCRUTINIZED COMPANY CERTIFICATION.....	1
00422	E-VERIFY CERTIFICATION.....	1
00423	NON-COLLUSION CERTIFICATE.....	1
00430	SUBCONTRACTORS LIST	1 - 3
00440	BIDDER'S SELECTION OF PAYMENT METHOD.....	1 - 2
00500	AWARD OF CONTRACT AND EXECUTION OF CONTRACT BONDS	1 - 3
00510	CONTRACT.....	1 - 10
00610	COMMON LAW PERFORMANCE BOND	1 - 2
00620	STATUTORY PAYMENT BOND SURETY PAYMENT AND PERFORMANCE BOND AFFIDAVIT	1 - 3

TPF & PCM / PERIMETER FENCE REHABILITATION

TABLE OF CONTENTS

SECTION	TITLE	PAGES
00650	INSURANCE REQUIREMENTS	1 - 6
00700	GENERAL CONDITIONS OF THE CONTRACT FOR CONSTRUCTION	1 – 61
00820	WOMAN AND MINORITY OWNED BUSINESS ENTERPRISE	1
00830	CONSTRUCTION CONTRACT CLAUSES AND AIRPORT IMPROVEMENT PROGRAM.....	1 - 21
00850	DRAWING INDEX.....	1
DIVISION 01 - GENERAL REQUIREMENTS		
01010	SUMMARY OF WORK	1 - 5
01015	MOBILIZATION	1
01020	OWNER’S ALLOWANCES	1 - 3
01040	PROJECT COORDINATION	1 - 5
01045	CUTTING AND PATCHING.....	1 - 5
01050	FIELD ENGINEERING	1 - 3
01095	DEFINITIONS AND STANDARDS.....	1 - 13
01110	AIRPORT PROJECT PROCEDURES	1 - 12
01150	MEASUREMENT AND PAYMENT	1 - 4
01315	SCHEDULES, PHASING (Bar Chart)	1 - 4
01340	SHOP DRAWINGS, PRODUCT DATA, AND SAMPLES	1 - 14
01370	SCHEDULE OF VALUES.....	1 - 3
01390	CONTROL OF WORK.....	1 - 4
01540	CONSTRUCTION SAFETY AND SECURITY REQUIREMENTS	1 - 13
01545	UTILITIES	1 - 5
01560	PREVENTION, CONTROL AND ABATEMENT OF EROSION AND WATER POLLUTION.....	1 - 2
01561	CONSTRUCTION CLEANING.....	1 - 3
01600	MATERIALS AND EQUIPMENT.....	1 - 4

TABLE OF CONTENTS

SECTION	TITLE	PAGES
01605	PRODUCTS AND SUBSTITUTIONS.....	1 - 11
01640	PRODUCT HANDLING.....	1 - 3
01650	CONSTRUCTION SALVAGE AND WASTE MANAGEMENT	1 - 6
01700	PROJECT CLOSEOUT	1 - 12
01740	WARRANTIES.....	1 - 4

TECHNICAL SPECIFICATIONS

SECTION	TITLE	PAGES
P-100	MOBILIZATION AND GENERAL CONDITIONS	1-2
P-102	SAFETY AND SECURITY	1-6
P-105	TEMPORARY CONSTRUCTION ITEMS.....	1
F-162	CHAIN-LINK FENCE	1-6
T-101	TREE TRIMMING AND REMOVAL	1-3
T-901	SEEDING	1-5
T-904	SODDING.....	1-5
T-905	TOPSOILING.....	1-3
T-908	MULCHING	1-3

EXHIBIT A – AVIATION AUTHORITY APPLICATION FOR PAYMENT

END OF SECTION



Hillsborough County Aviation Authority
Solicitation Addendum

Addendum No.: 1
Solicitation No.: 17-411-013
Project No.: 6440 17
Solicitation Title: Perimeter Fence Rehabilitation
Addendum Date: May 16, 2017
Procurement Agent: Joe Benjamin

NOTE: The due date for submission of the response remains on **June 13, 2017 by 2:00 p.m.**

THE FOLLOWING ITEMS ARE MADE AND HEREBY BECOME A PART OF THIS SOLICITATION AS PREPARED BY PROCUREMENT:

A second site visit for reviewing the Tree Trimming and Removal requirements at Plant City Municipal Airport has been scheduled for May 23, 2017 at 2:00 p.m. Interested parties should meet Authority staff at the Plant City Municipal Airport main terminal at the date and time specified.

Q1. Is there any tree trimming or removal involved in the project?

R1. Yes. **Item T-101 TREE TRIMMING AND REMOVAL, Section 101-2.1 STANDARDS of the Technical Specifications states:** "The Contractor shall employ or obtain the services of a Certified Arborist to oversee the tree trimming operations. All trimming and removal shall be done in accordance with the National Arborist Association (NAA) Planting Standards, CNSI A300 Pruning Standards, and International Society of Arboriculture (ISA) Tree Pruning Guidelines for Crown Thinning and Height Reduction, and Hillsborough County requirements."

End of Addendum

INSTRUCTIONS:

Respondent must acknowledge receipt of this Addendum as instructed in the solicitation document. Failure to acknowledge receipt of this Addendum may result in the disqualification of Respondent's response.



Hillsborough County Aviation Authority
Solicitation Addendum

Addendum No.: 2
Solicitation No.: 17-411-013
Project No.: 6440 17
Solicitation Title: Perimeter Fence Rehabilitation
Addendum Date: June 6, 2017
Procurement Agent: Joe Benjamin

NOTE: The due date for submission of Bids remains on **June 13, 2017 by 2:00 p.m.**

THE FOLLOWING ITEMS ARE MADE AND HEREBY BECOME A PART OF THIS SOLICITATION AS PREPARED BY PROCUREMENT:

Replace:

Remove Section 00340- BID SCHEDULE and **REPLACE** with the attached revised Section 00340 – BID SCHEDULE in its entirety.

Replace:

Remove Drawing G001 and **REPLACE** with the attached revised Drawing G001 in its entirety.

Replace:

Remove Drawing G003 and **REPLACE** with the attached revised Drawing G003 in its entirety.

Replace:

Remove Drawing G006 and **REPLACE** with the attached revised Drawing G006 in its entirety.

Replace:

Remove Drawing C101 and **REPLACE** with the attached revised Drawing C101 in its entirety.

Replace:

Remove Drawing C103 and **REPLACE** with the attached revised Drawing C103 in its entirety.

Replace:

Remove Drawing C301 and **REPLACE** with the attached revised Drawing C301 in its entirety.

Q1: Sheet G006 has a construction schedule for Phase 1 and 2. Are these phases subject to liquidated damages? They both seem to be on the aggressive side, as to the scopes involved.

R1: See attached revised Drawing G006. The intent of the phasing shown on Drawing G006 is such that the Area 1 fence at Peter O. Knight Airport (POK) is installed in its entirety prior to the Aircraft Owners and Pilots Association (AOPA) event being held at POK. Work in Areas 2 and 3 may be completed after the conclusion of the AOPA event on October 28, 2017. In addition, tree clearing/trimming work may occur at Plant City Airport in advance of Phase 2 fence work beginning. Liquidated damages may be assessed per the Contract Documents for work completed beyond the substantial completion date.

Q2: At the Peter O' Knight site, can the new fence line be offset 12-18" so posts could be set, with the existing fence remaining, to help keep a secure sight?

R2: The fence at Peter O. Knight shall be removed and replaced in its existing alignment as indicated on the Plans.

Q3: Sheet C-301, Swing gate detail shows the gate frame to be 2 3/8" which is not standard. 1 5/8" or 2" frame would be more of a standard for the industry.

R3: See attached revised Drawing C301.

Q4: Bid Item- F-162-6 – fence bottom regrading has a lump sum for the unit/amount. Should there be a quantity to go by on this item?

R4: Item F-162-6 refers to the regrading and sodding required beneath the fence as shown on Drawing C103. Payment shall be lump sum for all work associated with the regrading. See Drawing C103 for approximate dimensions and specific requirements associated with this item of work. Minor grading beneath new fence to meet the 3" maximum gap shown on detail 2, Drawing C301 shall be considered incidental to the fence installation pay item.

Q5: There are specifications for the methods of finishing the ground after trees have been removed. There is Sodding T-904, Seeding T-901, Top soiling T-905, and Mulching T-908; are all of these methods required to complete the clearing bid item?

R5: Restoration of clearing areas by seeding or sodding is not required. Upon completion of clearing activities, the ground shall be graded smooth and level with the surrounding ground such that a drivable surface is provided. Top-soiling and sodding is required to establish the regrading area associated with Item F-162-6. Seeding and mulching, if required, shall be used to restore the staging area and haul routes per the notes on Drawing G005.

Q6: Will there be an additional site visit scheduled?

R6: No.

End of Addendum

INSTRUCTIONS:

Bidders must acknowledge receipt of this Addendum as instructed in the solicitation document. Failure to acknowledge receipt of this Addendum may result in the disqualification of Bidder's Bid.

Perimeter Fence Rehabilitation
HCAA Project No. 6440 17
Plant City Airport and Peter O. Knight Airport
Hillsborough County Aviation Authority

Bid Item Number	Item Description and Bid Price Per Unit <i>(In Words)</i>	Bid Price Per Unit <i>(In Numbers)</i>	Est Qty	Unit	Total Amount Per Item <i>Unit Price Times Est Qty</i>
P-100-1	Mobilization (Including Safety and Security)		1	LS	
	<i>Dollars</i> _____ <i>Cents</i> _____	\$ _____			
	<i>Bid Price Per Unit In Words</i>	<i>In Numbers</i>			
F-162-1	Chain-Link Fence Removal		10,800	LF	
	<i>Dollars</i> _____ <i>Cents</i> _____	\$ _____			
	<i>Bid Price Per Unit In Words</i>	<i>In Numbers</i>			
F-162-2	6' Chain-Link Fence, Black Vinyl Coated with/without 3 Strand Barbed Wire		8,255	LF	
	<i>Dollars</i> _____ <i>Cents</i> _____	\$ _____			
	<i>Bid Price Per Unit In Words</i>	<i>In Numbers</i>			
F-162-3	6' Chain-Link Fence, Galvanized with 3 Strand Barbed Wire		2,425	LF	
	<i>Dollars</i> _____ <i>Cents</i> _____	\$ _____			
	<i>Bid Price Per Unit In Words</i>	<i>In Numbers</i>			
F-162-4	Swing Gate (Plant City Airport), Size Varies		1	LS	
	<i>Dollars</i> _____ <i>Cents</i> _____	\$ _____			
	<i>Bid Price Per Unit In Words</i>	<i>In Numbers</i>			
F-162-5	Swing Gate (Peter O. Knight Airport), Size Varies		1	LS	
	<i>Dollars</i> _____ <i>Cents</i> _____	\$ _____			
	<i>Bid Price Per Unit In Words</i>	<i>In Numbers</i>			

Bid Item Number	Item Description and Bid Price Per Unit <i>(In Words)</i>	Bid Price Per Unit <i>(In Numbers)</i>	Est Qty	Unit	Total Amount Per Item <i>Unit Price Times Est Qty</i>
F-162-6	Fence Bottom Regrading	Dollars _____ Cents \$ _____	1	LS	\$ _____
	<i>Bid Price Per Unit In Words</i>	<i>In Numbers</i>			
F-162-7	Fence Signage	Dollars _____ Cents \$ _____	1	LS	\$ _____
	<i>Bid Price Per Unit In Words</i>	<i>In Numbers</i>			
F-162-8	Swing Gate Hinge Replacement (Double Leaf Gate)	Dollars _____ Cents \$ _____	3	EA	\$ _____
	<i>Bid Price Per Unit In Words</i>	<i>In Numbers</i>			
T-101-1	Clearing, 10' Wide Along Fence Alignment	Dollars _____ Cents \$ _____	3,250	LF	\$ _____
	<i>Bid Price Per Unit In Words</i>	<i>In Numbers</i>			
T-101-2	Trimming, Above Existing Fence Alignment	Dollars _____ Cents \$ _____	1,425	LF	\$ _____
	<i>Bid Price Per Unit In Words</i>	<i>In Numbers</i>			
Sub-total for all Bid Items not including Owner's Allowance					\$ _____
Owner's Allowance					
	Twenty Thousand	Dollars _____ Zero _____ Cents \$ _____	1	Allow	\$ _____ 20,000.00
	<i>Bid Price Per Unit In Words</i>	<i>In Numbers</i>			

Bid Item Number	Item Description and Bid Price Per Unit <i>(In Words)</i>	Bid Price Per Unit <i>(In Numbers)</i>	Est Qty	Unit	Total Amount Per Item <i>Unit Price Times Est Qty</i>
--------------------	--	--	------------	------	---

Total Bid Amount including Owner's Allowance

_____ Dollars _____ Cents \$ _____
Total Bid Amount in Words *In Numbers*

NOTE: Basis of payment will be in accordance with the technical specifications applicable to each Bid Item Number.

Name of Bidder: _____
(Typed or Printed)

Signature of Bidder: _____
(Same as Bid Form)

Title: _____

Date: _____

SUMMARY OF QUANTITIES

ITEM NUMBER	ITEM DESCRIPTION	UNIT	BID QUANTITY	CHANGE ORDERS					FINAL QUANTITY	REMARKS
				CCO #1	CCO #2	CCO #3	CCO #4	CCO #5		
GENERAL										
P-100-1	MOBILIZATION (INCLUDING SAFETY AND SECURITY)	LS	1							
CIVIL - PLANT CITY AIRPORT										
F-162-1	CHAIN-LINK FENCE REMOVAL	LF	3,000							
F-162-2	6' CHAIN-LINK FENCE, BLACK VINYL COATED WITH/WITHOUT 3 STRAND BARBED WIRE	LF	570							
F-162-3	6' CHAIN-LINK FENCE, GALVANIZED WITH 3 STRAND BARBED WIRE	LF	2,425							
F-162-4	SWING GATE (PLANT CITY AIRPORT), SIZE VARIES	LS	1							
F-162-6	FENCE BOTTOM REGRADING	LS	1							
F-162-7	FENCE SIGNAGE	LS	1							
F-162-8	SWING GATE HINGE REPLACEMENT (DOUBLE LEAF GATE)	EA	3							
T-101-1	CLEARING, 10' WIDE ALONG FENCE ALIGNMENT	LF	3,250							
T-101-2	TRIMMING ALONG EXISTING FENCE ALIGNMENT	LF	1,425							
CIVIL - PETER O. KNIGHT AIRPORT										
F-162-1	CHAIN-LINK FENCE REMOVAL	LF	7,800							
F-162-2	6' CHAIN-LINK FENCE, BLACK VINYL COATED WITH/WITHOUT 3 STRAND BARBED WIRE	LF	7,685							
F-162-5	SWING GATE (PETER O. KNIGHT AIRPORT), SIZE VARIES	LS	1							
F-162-7	FENCE SIGNAGE	LS	1							

BY	DAE	MJS
REVISIONS	NO. 2	
DATE	5/5/16	

RS&H, Inc.
 1715 N. Westshore Blvd., Suite 500
 Tampa, FL 33607-2999
 www.rsandh.com
 FL ERO0000088
 ERO0000020 UC0000210

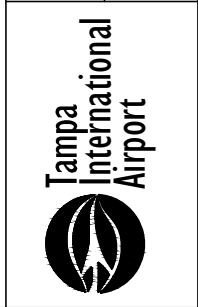
PROJECT NAME
 PERIMETER FENCE REHABILITATION
 PLANT CITY AIRPORT, PLANT CITY, FL
 PETER O. KNIGHT AIRPORT, TAMPA, FL

F.A.A. NO. NA
 HCAA NO. 6440 17
 JOB NO. 204-0001-032
 DESIGN DAE
 DRAWN SCS
 CHECKED MJS
 FILE NAME -
 SCALE: AS SHOWN
 DATE: MAY 8, 2017

SHEET TITLE
 SUMMARY OF QUANTITIES
 G001

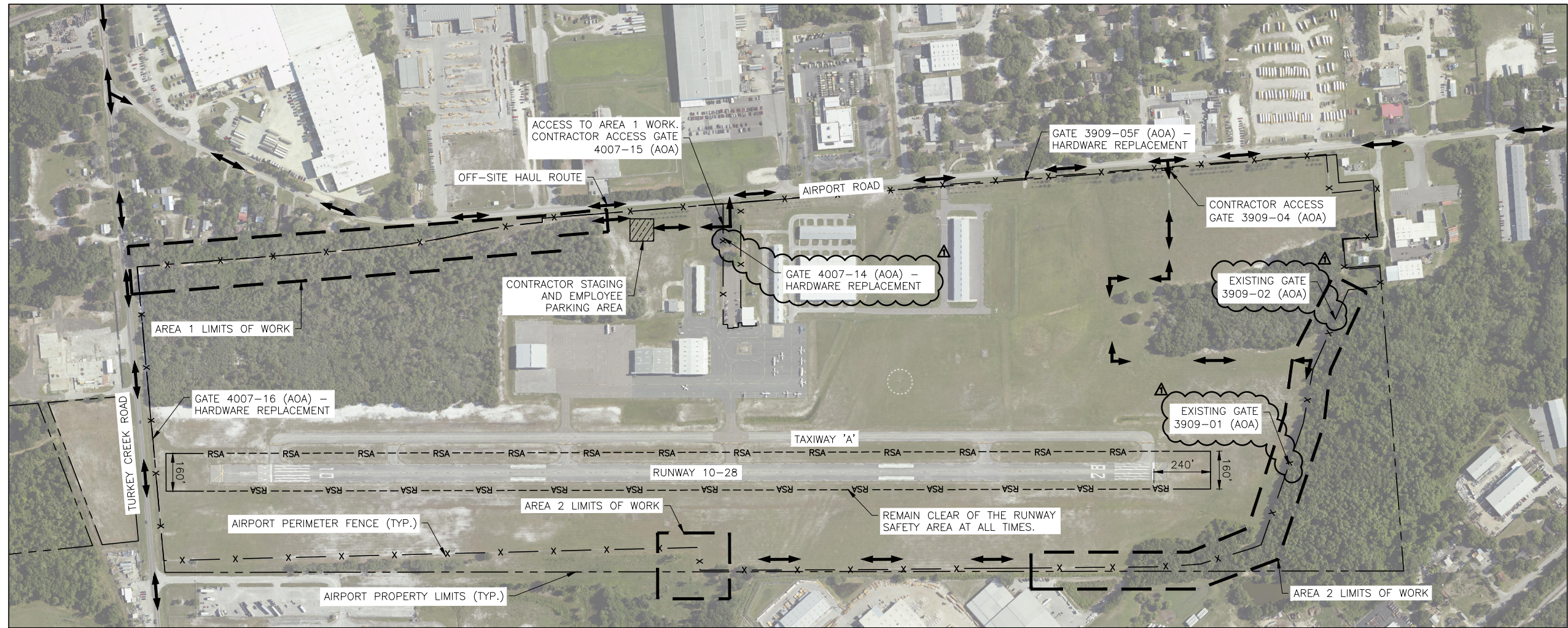

CONTRACT LAYOUT PLAN NOTES

- FOR GENERAL NOTES AND CONTRACTOR'S STAGING AREA NOTES, SEE SHEET G005.
- FOR PHASING INFORMATION, SEE SHEET G006.
- FOR THE WORK DETAILS ASSOCIATED WITH EACH WORK AREA, REFER TO THE "C" SERIES SHEETS.
- ACCESS TO THE SITE SHALL BE AS SHOWN ON THIS SHEET. THE CONTRACTOR SHALL NOT UTILIZE ALTERNATIVE ROUTES UNLESS PREVIOUSLY APPROVED BY THE CONSTRUCTION MANAGER.
- IT SHALL BE THE RESPONSIBILITY OF THE CONTRACTOR TO COORDINATE OFF-SITE HAUL ROUTES (STATE HIGHWAYS, COUNTY ROADS OR CITY STREETS AS REQUIRED) WITH THE APPROPRIATE OWNER, GOVERNING THE JURISDICTION OVER THE AFFECTED ROUTE.
- THE CONTRACTOR SHALL KEEP BOTH ON AND OFF SITE HAUL ROUTES CLEAN AND FREE OF DEBRIS AND DUST AT ALL TIMES. THE CONTRACTOR SHALL BE REQUIRED TO CLEAN HAUL ROUTES AS REQUIRED.
- AT NO TIMES SHALL THE CONTRACTOR UTILIZE ACTIVE AIRFIELD PAVEMENTS FOR ON SITE HAUL ROUTES.
- ACCESS TO AIRPORT PROPERTY IS THROUGH EXISTING AIRPORT GATES. GATES TO REMAIN CLOSED AND LOCKED WHEN NOT IN USE.
- THE CONTRACTOR SHALL BE RESPONSIBLE FOR KEEPING THE AIRPORT SECURE AT ALL TIMES DURING CONSTRUCTION.
- THE CONTRACTOR SHALL KEEP THE WORK SITE SECURE IN THAT THE REMOVAL OF EXISTING FENCE SHALL COINCIDE WITH INSTALLATION OF NEW FENCE. SEE SITE SECURITY NOTES ON SHEET G002.
- CONTRACTOR SHALL COORDINATE, THROUGH THE CONSTRUCTION MANAGER, FOR ACCESS TO AREA 1 OFF AIRPORT TREE TRIMMING/CLEARING AREAS.

LEGEND

- AIRPORT PROPERTY LIMITS
- ACCESS AND HAUL ROUTE
- CONTRACTOR STAGING AND EMPLOYEE PARKING AREA
- EXISTING FENCE
- LIMITS OF FENCE/GATE WORK

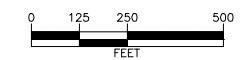

BY AUTH.	DAG	MJS
	DAG	MJS
REVISIONS	ADDENDUM NO. 2	
DATE	5/5/16	
RS&H, Inc. Suite 500 1715 N. Westshore Blvd. Suite 500 Tampa, Florida 33607-3999 www.rsandh.com LICENSE NO. WQ0200086 EXPIRES 06/30/2018		
PROJECT NAME PERIMETER FENCE REHABILITATION PLANT CITY AIRPORT, PLANT CITY, FL PETER O. KNIGHT AIRPORT, TAMPA, FL		
F.A.A. NO.	NA	
HCA NO.	6440 17	
JOB NO.	204-0001-032	
DESIGN	DAG	
DRAWN	SCS	
CHECKED	MJS	
FILE NAME	-	
SCALE:	AS SHOWN	
DATE:	MAY 8, 2017	
SHEET TITLE	CONTRACT LAYOUT PLAN - PCA	
G003		

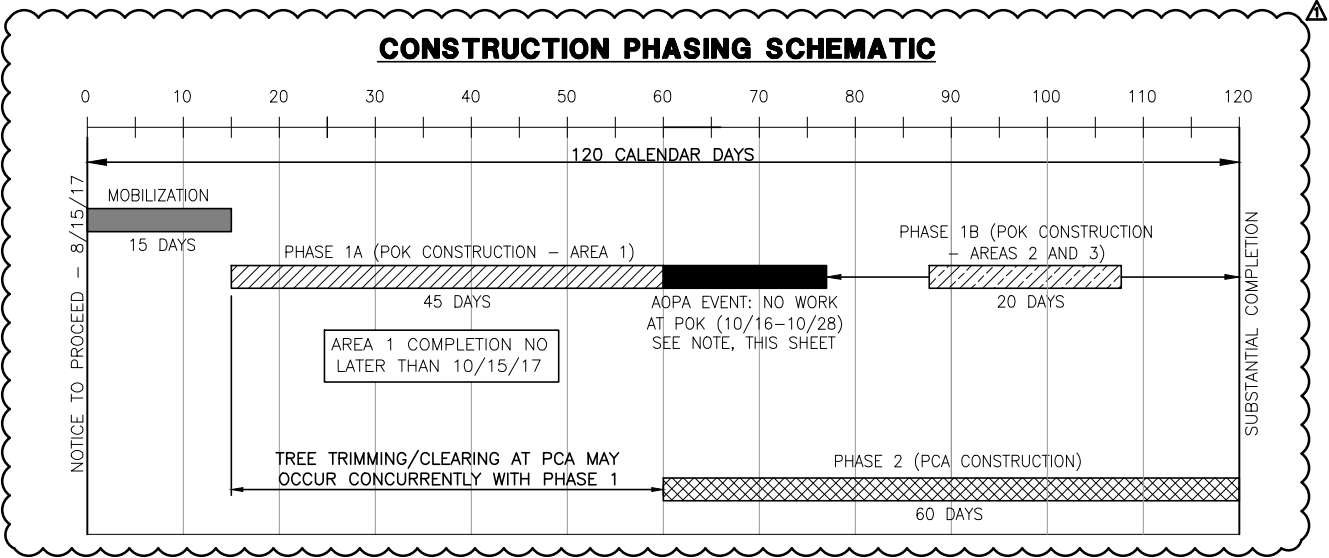

PHASING DESCRIPTIONS

THE PROJECT CONSISTS OF THREE (3) PHASES. DESCRIPTIONS OF EACH OF THE PHASES IDENTIFIED ARE AS FOLLOWS:

MOBILIZATION

THE CONTRACTOR SHALL UTILIZE THIS PHASE TO MOBILIZE FOR CONSTRUCTION. MOBILIZATION SHALL INCLUDE, BUT NOT LIMITED TO, THE DEVELOPMENT OF A COMPREHENSIVE CONSTRUCTION SCHEDULE, PREPARATION AND SUBMISSION OF ALL SHOP DRAWINGS FOR REVIEW AND APPROVAL, COORDINATION OF ANY PERMITTING REQUIREMENTS, ORDERING OF MATERIALS (SPECIAL ATTENTION SHALL BE PAID TO ITEMS WITH LONG LEAD TIMES), ETC. IT IS THE INTENT OF THIS PHASE TO PROVIDE THE CONTRACTOR WITH SUFFICIENT TIME TO COMPLETE ALL TASKS REQUIRED TO FULLY MOBILIZE BEFORE BREAKING GROUND ON THE CONSTRUCTION SITE. THE CONTRACTOR HAS 15 CONSECUTIVE CALENDAR DAYS FOR MOBILIZATION.

ADDITIONALLY, THE PRE-CONSTRUCTION CONFERENCE SHALL BE CONDUCTED DURING THIS PHASE TO FAMILIARIZE THE CONTRACTOR WITH THE PROJECT SITE, OPERATIONS REQUIREMENTS AND OTHER GENERAL PROJECT REQUIREMENTS.

PHASE 1A - PETER O. KNIGHT AIRPORT CONSTRUCTION - AREA 1

PHASE 1A CONSISTS OF THE COMPLETE CONSTRUCTION OF THE AREA 1 FENCE AT PETER O. KNIGHT AIRPORT INCLUDING, BUT NOT LIMITED TO, THE REMOVAL OF ALL FENCE IDENTIFIED FOR REMOVAL, THE INSTALLATION OF NEW FENCE, INSTALLATION OF SIGNAGE, AND THE INSTALLATION OF NEW ACCESS GATES. THE CONTRACTOR HAS 45 CONSECUTIVE CALENDAR DAYS FOR PHASE 1. SEE NOTE BELOW.

NO WORK SHALL OCCUR AT PETER O. KNIGHT AIRPORT FROM 10/16 TO 10/28 FOR THE AOPA EVENT BEING HOSTED AT THE AIRPORT. NO STAGING OF MATERIALS ON SITE, INCLUDING THE DESIGNATED STAGING AREAS, WILL BE PERMITTED DURING THIS PERIOD. CONTRACTOR SHALL COORDINATE WITH THE CONSTRUCTION MANAGER TWO WEEKS PRIOR TO THE EVENT FOR THE REMOVAL OF MATERIALS AND EQUIPMENT FROM THE STAGING AREA.

PHASE 1B - PETER O. KNIGHT AIRPORT CONSTRUCTION - AREAS 2 AND 3

PHASE 1B CONSISTS OF THE COMPLETE CONSTRUCTION OF THE AREAS 2 AND 3 FENCE AT PETER O. KNIGHT AIRPORT INCLUDING, BUT NOT LIMITED TO, THE REMOVAL OF ALL FENCE IDENTIFIED FOR REMOVAL, THE INSTALLATION OF NEW FENCE, INSTALLATION OF SIGNAGE, AND THE INSTALLATION OF NEW ACCESS GATES. THE CONTRACTOR HAS 20 CONSECUTIVE CALENDAR DAYS FOR PHASE 1. SEE NOTE BELOW.

PHASE 2 - PLANT CITY AIRPORT CONSTRUCTION

PHASE 2 CONSISTS OF THE COMPLETE CONSTRUCTION OF THE PROJECT AT PLANT CITY AIRPORT INCLUDING, BUT NOT LIMITED TO, THE REMOVAL OF ALL FENCE IDENTIFIED FOR REMOVAL, THE INSTALLATION OF ALL NEW FENCE, INSTALLATION OF SIGNAGE, REPLACEMENT OF SELECT GATE HINGES AND THE INSTALLATION OF ALL NEW ACCESS GATES. THE COMPLETION OF THIS PHASE SHALL CONSTITUTE SUBSTANTIAL COMPLETION OF THE PROJECT. THE CONTRACTOR HAS 60 CONSECUTIVE CALENDAR DAYS FOR PHASE 2.

NOTE: TREE TRIMMING AND CLEARING WORK MAY OCCUR AT PLANT CITY AIRPORT DURING PHASE 1 WORK AT POK.

PHASING NOTES

- FOR CONTRACT LAYOUT PLANS AND ASSOCIATED NOTES, REFER TO SHEETS G003 AND G004.
- CONTRACT LAYOUT PLAN INCLUDES A GRAPHICAL DEPICTION OF THE LIMITS OF WORK ASSOCIATED WITH EACH WORK AREA.
- FOR THE WORK DETAILS ASSOCIATED WITH EACH WORK AREA, REFER TO THE "C" SERIES SHEETS.
- THE CONTRACTOR SHALL SUPPLY A COMPLETE AND DETAILED CONSTRUCTION SCHEDULE TO THE CONSTRUCTION MANAGER FOR REVIEW AND APPROVAL PRIOR TO COMMENCING CONSTRUCTION. THE CONTRACTOR SHALL NOT REVISE THE SCHEDULE WITHOUT THE WRITTEN APPROVAL OF THE CONSTRUCTION MANAGER.
- THE DURATIONS INCLUDED FOR PHASING ARE CONSECUTIVE CALENDAR DAYS. NOTE THAT WORK DAYS ARE MONDAY THROUGH FRIDAY AS INDICATED IN THE PROJECT SPECIFICATIONS.
- WORK HOURS SHALL BE 7AM TO 7PM, MONDAY TO FRIDAY, UNLESS OTHERWISE NOTED.
- 48 HOUR'S NOTICE SHALL BE PROVIDED PRIOR TO BEGINNING ANY CONSTRUCTION ACTIVITIES TO ENSURE THAT APPROPRIATE NOTAMS ARE ISSUED.

F	BY	DAE	MJS
	REVISIONS	ADDENDUM NO. 2	
F	DATE	5/5/16	
E	RS&H, Inc. 1715 N. Westshore Blvd., Suite 500 Tampa, FL 33607-2999 www.rsandh.com FL ERO0000088 ERO0000020 LIC0000210		
E			
D			
C	PROJECT NAME	PERIMETER FENCE REHABILITATION PLANT CITY AIRPORT, PLANT CITY, FL PETER O. KNIGHT AIRPORT, TAMPA, FL	
B	FAA NO.	NA	
B	HCAA NO.	6440 17	
B	JOB NO.	204-0001-032	
B	DESIGN	DAE	
B	DRAWN	SCS	
B	CHECKED	MJS	
B	FILE NAME	-	
B	SCALE:	AS SHOWN	
B	DATE:	MAY 8, 2017	
A	SHEET TITLE	OVERALL CONSTRUCTION PHASING NOTES AND SCHEMATIC	
A	<h1>G006</h1>		

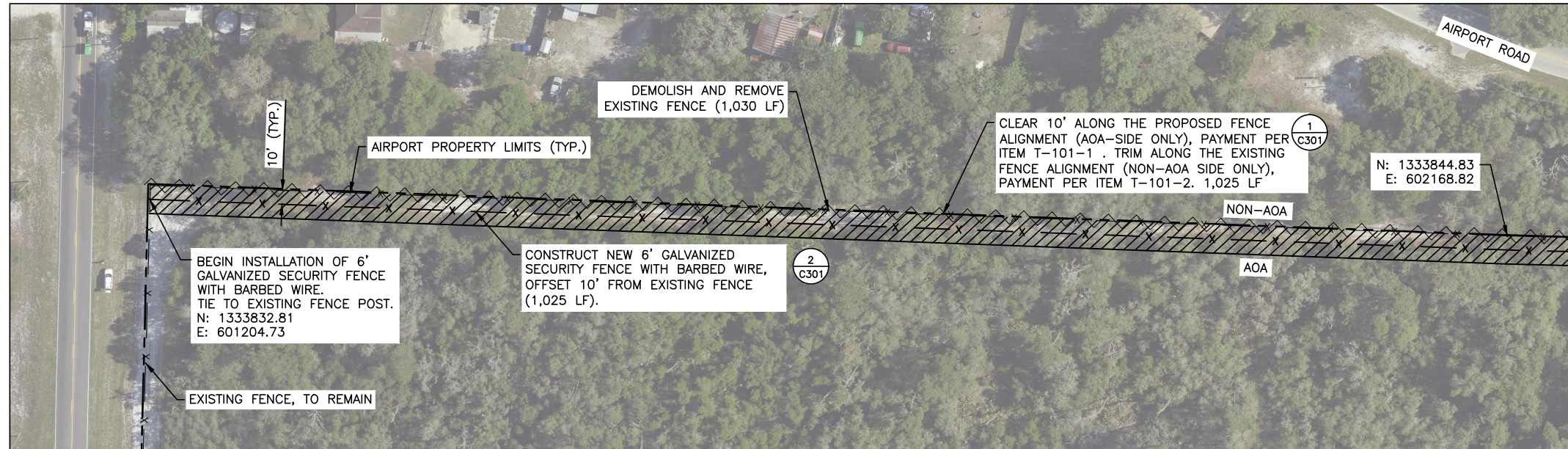

1 FENCE PLAN - AREA 1
C101

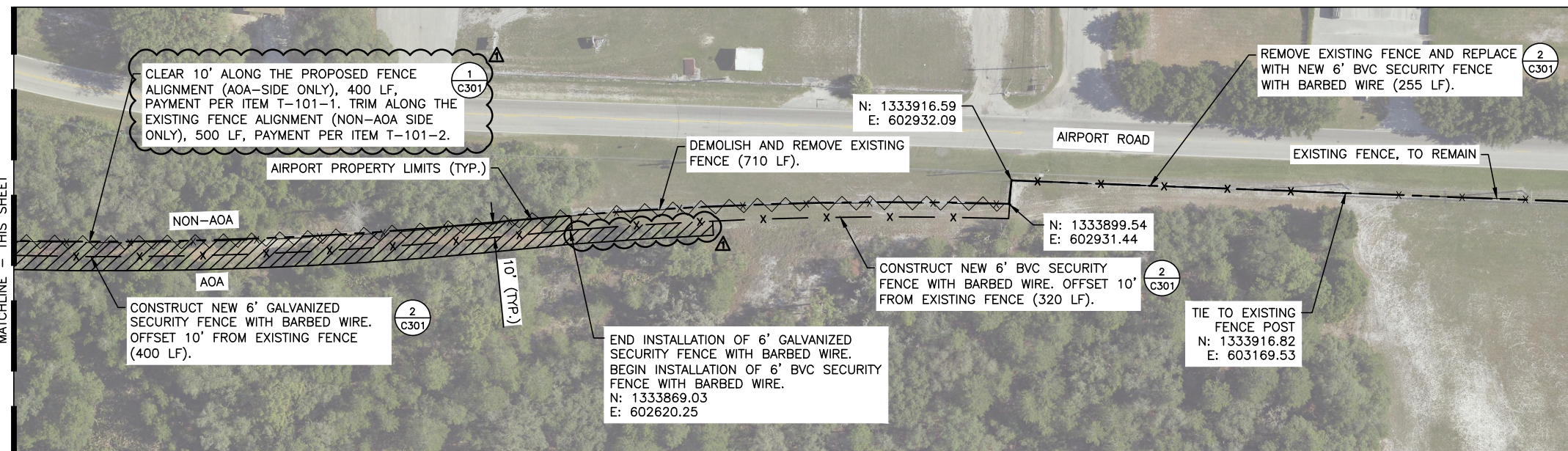
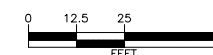

2 FENCE PLAN - AREA 1
C101

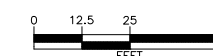

THERE ARE EXISTING UNDERGROUND UTILITIES IN THE PROJECT WORK AREA. IT SHALL BE THE RESPONSIBILITY OF THE CONTRACTOR TO HAVE EVERY UNDERGROUND UTILITY LOCATED, FLAGGED, AND IDENTIFIED PRIOR TO CONSTRUCTION. ANY DAMAGE DONE TO ANY EXISTING UTILITIES SHALL BE THE RESPONSIBILITY OF THE CONTRACTOR. THE CONTRACTOR SHALL IMMEDIATELY REPAIR ANY UTILITY DAMAGED BY HIS ACTIONS WITH NO ADDITIONAL COMPENSATION.

LEGEND

- AIRPORT PROPERTY LIMITS
- ROFA — RUNWAY OBJECT FREE AREA
- RSA — RUNWAY SAFETY AREA
- x — NEW FENCE
- x — EXISTING FENCE
- x — DEMOLISH AND REMOVE EXISTING FENCE
- BVC BLACK VINYL COATED
- /// CLEAR/TRIM ALONG FENCE, SEE DETAIL 1, SHEET C301

NOTES

1. NORTHINGS AND EASTINGS ARE APPROXIMATE AND PROVIDED TO ASSIST THE CONTRACTOR WITH FIELD LAYOUT. THE CONTRACTOR SHALL STAKE LIMITS OF FENCE REPLACEMENT AND FIELD VERIFY THE EXACT LOCATION OF ALL FENCE WITH THE CONSTRUCTION MANAGER PRIOR TO INSTALLATION. FENCE SHALL BE REMOVED AND REPLACED IN ITS EXISTING ALIGNMENT.
2. FENCE DEMOLITION SHALL INCLUDE THE REMOVAL OF FENCE POST FOUNDATIONS AND BACKFILLING OF HOLES AS NECESSARY. PAYMENT SHALL BE INCLUDED IN THE F-162-1 PAY ITEM. FENCE DEMOLITION SHALL BE TO THE NEAREST EXISTING POST.
3. TIE ALL PROPOSED FENCE TO EXISTING FENCE AT NEAREST EXISTING FENCE POST.
4. CONTRACTOR IS RESPONSIBLE FOR INSTALLATION OF FENCE REGARDLESS OF SITE CONDITIONS.
5. THE FENCE SHALL BE REMOVED AND REPLACED IN ITS EXISTING ALIGNMENT.
6. CONTRACTOR IS RESPONSIBLE FOR MAINTAINING A COMPLETE AND SECURE AOA PERIMETER AT THE END OF EACH WORK SHIFT. REFER TO SHEET G002 FOR REQUIREMENTS.
7. CONTRACTOR SHALL COORDINATE, THROUGH THE CONSTRUCTION MANAGER, FOR ACCESS TO AREA 1 OFF AIRPORT TREE TRIMMING/CLEARING AREAS.

SIGNAGE WORK
CONTRACTOR SHALL INSTALL NO TRESPASSING SIGNAGE ALONG THE EXTENT OF THE AOA PERIMETER (APPROXIMATELY 14,500 FEET). NEW SIGNS SHALL BE INSTALLED AT 200' INTERVALS. ALL EXISTING NO TRESPASSING SIGNS SHALL BE REMOVED.

GATE HINGE REPLACEMENT
CONTRACTOR SHALL REPLACE THE SWING GATE HINGES AND RELATED EQUIPMENT AT THE FOLLOWING GATES:
3909-05F - 24' DOUBLE LEAF, BVC
4007-14 - 24' DOUBLE LEAF, BVC
4007-16 - 24' DOUBLE LEAF, GALVANIZED
CONTRACTOR SHALL FIELD VERIFY EXISTING GATE HINGE TYPE, MATERIAL, AND COLOR. NEW HINGES AND EQUIPMENT SHALL MATCH EXISTING GATE MATERIAL AND COLOR. CONTRACTOR SHALL REMOVE AND RESET EXISTING GATE POSTS IN NEW FOOTINGS AS REQUIRED TO ENSURE GATE IS PROPERLY ALIGNED. SEE SHEET G003 FOR GATE LOCATIONS. PAYMENT SHALL BE INCLUSIVE OF THE F-162-7 PAY ITEM.

KEY MAP

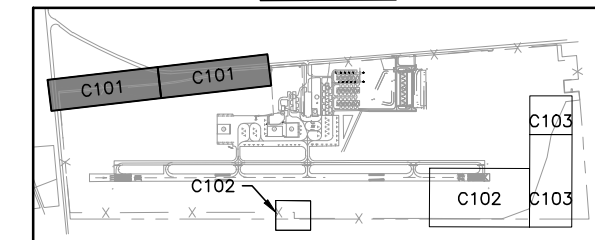

AUTH.	BY	DAE	MJS
	REVISIONS	NO. 2	
DATE	5/5/16	ADDENDUM NO. 2	
	RS&H, Inc. 1715 N. Westshore Blvd., Suite 500 Tampa, FL 33609-2550 www.rsandh.com ER00002620 UC000020		
PERIMETER FENCE REHABILITATION PLANT CITY AIRPORT, PLANT CITY, FL PETER O. KNIGHT AIRPORT, TAMPA, FL			
F.A.A. NO.	NA		
HCAA NO.	6440 17		
JOB NO.	204-0001-032		
DESIGN	DAE		
DRAWN	SCS		
CHECKED	MJS		
FILE NAME	-		
SCALE:	AS SHOWN		
DATE:	MAY 8, 2017		
SHEET TITLE	FENCE PLAN - PCA AREA 1		
C101			

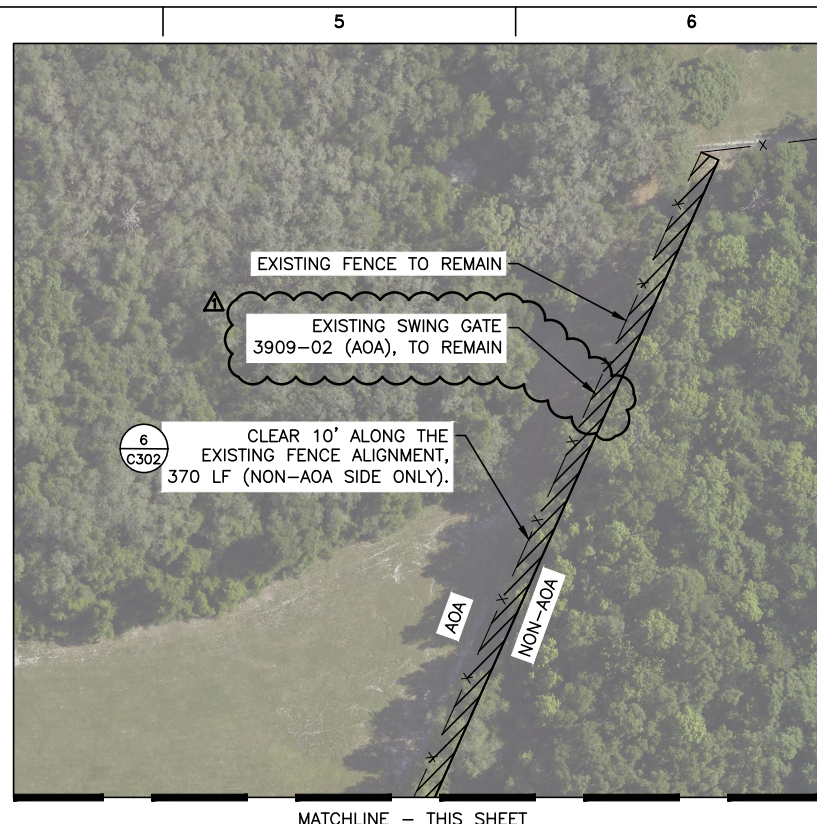
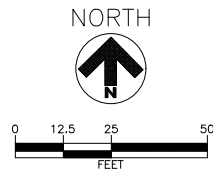
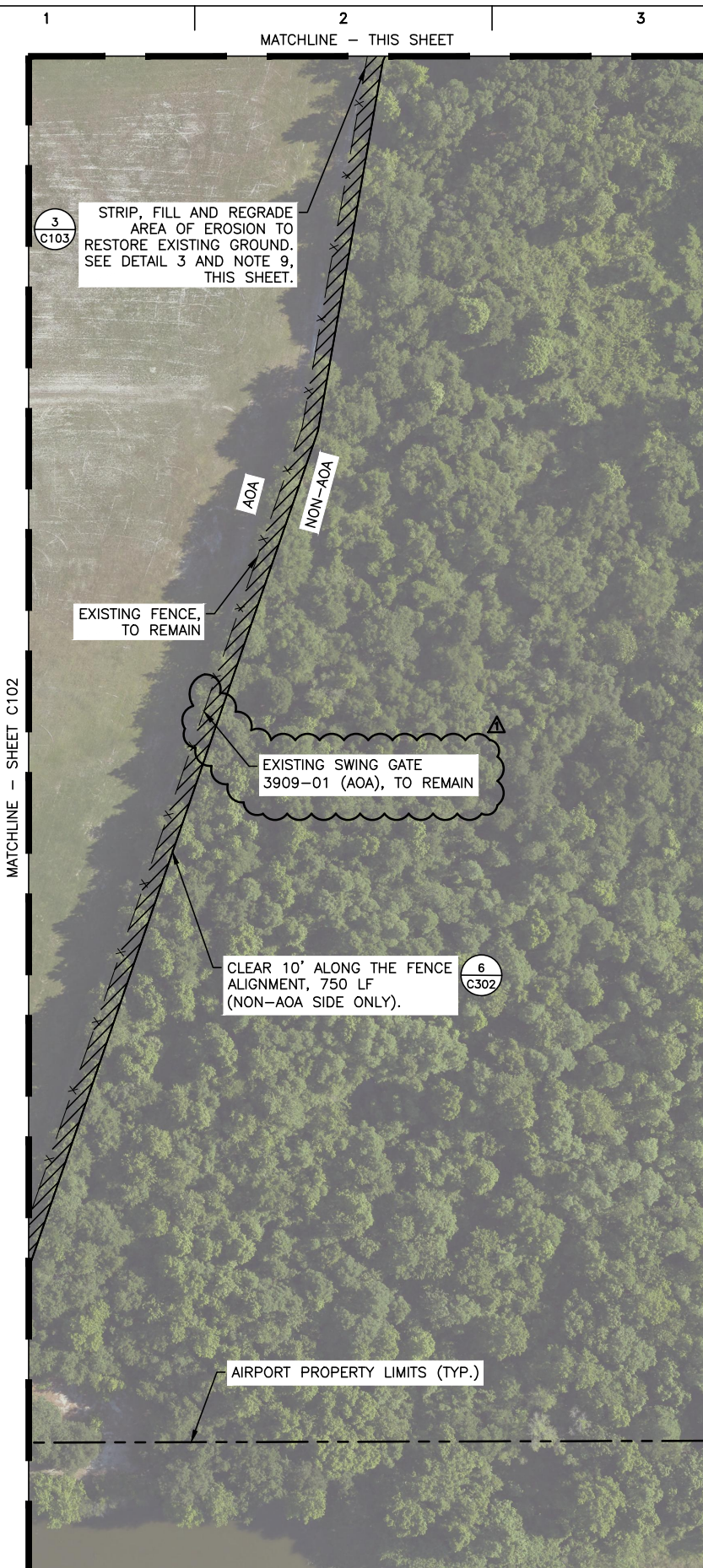

3 FENCE FOOTING EROSION PHOTO
C103

THERE ARE EXISTING UNDERGROUND UTILITIES IN THE PROJECT WORK AREA. IT SHALL BE THE RESPONSIBILITY OF THE CONTRACTOR TO HAVE EVERY UNDERGROUND UTILITY LOCATED, FLAGGED, AND IDENTIFIED PRIOR TO CONSTRUCTION. ANY DAMAGE DONE TO ANY EXISTING UTILITIES SHALL BE THE RESPONSIBILITY OF THE CONTRACTOR. THE CONTRACTOR SHALL IMMEDIATELY REPAIR ANY UTILITY DAMAGED BY HIS ACTIONS WITH NO ADDITIONAL COMPENSATION.

- LEGEND**
- AIRPORT PROPERTY LIMITS
 - ROFA — RUNWAY OBJECT FREE AREA
 - RSA — RUNWAY SAFETY AREA
 - X — NEW FENCE
 - X — EXISTING FENCE
 - X — DEMOLISH AND REMOVE EXISTING FENCE
 - BVC BLACK VINYL COATED
 - /// CLEAR/TRIM ALONG FENCE, SEE DETAIL 1, SHEET C301

- NOTES**
1. NORTHINGS AND EASTINGS ARE APPROXIMATE AND PROVIDED TO ASSIST THE CONTRACTOR WITH FIELD LAYOUT. THE CONTRACTOR SHALL STAKE LIMITS OF FENCE REPLACEMENT AND FIELD VERIFY THE EXACT LOCATION OF ALL FENCE WITH THE CONSTRUCTION MANAGER PRIOR TO INSTALLATION. FENCE SHALL BE REMOVED AND REPLACED IN ITS EXISTING ALIGNMENT.
 2. FENCE DEMOLITION SHALL INCLUDE THE REMOVAL OF FENCE POST FOUNDATIONS AND BACKFILLING OF HOLES AS NECESSARY. PAYMENT SHALL BE INCLUSIVE OF THE F-162-1 PAY ITEM. FENCE DEMOLITION SHALL BE TO THE NEAREST EXISTING POST.
 3. TIE ALL PROPOSED FENCE TO EXISTING FENCE AT NEAREST EXISTING FENCE POST.
 4. CONTRACTOR IS RESPONSIBLE FOR INSTALLATION OF FENCE REGARDLESS OF SITE CONDITIONS.
 5. THE FENCE SHALL BE REMOVED AND REPLACED IN ITS EXISTING ALIGNMENT.
 6. CONTRACTOR IS RESPONSIBLE FOR MAINTAINING A COMPLETE AND SECURE AOA PERIMETER AT THE END OF EACH WORK SHIFT. REFER TO SHEET G002 FOR DETAILS.
 7. CONTRACTOR SHALL COORDINATE, THROUGH THE CONSTRUCTION MANAGER, FOR ACCESS TO AREA 1 OFF AIRPORT TREE TRIMMING/CLEARING AREAS.
 8. CONTRACTOR SHALL CLEAR 10' BEYOND EXISTING FENCE LINE PER DETAIL 1, SHEET C301. PROTECT EXISTING FENCE TO REMAIN. FENCE DAMAGED AS A RESULT OF THE CONTRACTOR'S EFFORT SHALL BE REPAIRED OR REPLACED AT NO ADDITIONAL COST TO THE OWNER.
 9. CONTRACTOR SHALL INSTALL TOPSOIL AND SOD PER SPECIFICATIONS T-905 AND T-904 IN ALL DISTURBED AREAS. TOP OF FINISHED SOD SHALL BE NO GREATER THAN 3" BENEATH BOTTOM OF FENCE FABRIC. MAINTAIN AND WATER THE NEW SOD UNTIL IT IS ESTABLISHED BENEATH THE FENCE. PAYMENT SHALL BE INCLUSIVE OF THE F-162-6 PAY ITEM.

SIGNAGE WORK
CONTRACTOR SHALL INSTALL NO TRESPASSING SIGNAGE ALONG THE EXTENT OF THE AOA PERIMETER (APPROXIMATELY 14,500 FEET). ALL EXISTING NO TRESPASSING SIGNS SHALL BE REMOVED. NEW SIGNS SHALL BE INSTALLED AT 200' INTERVALS.

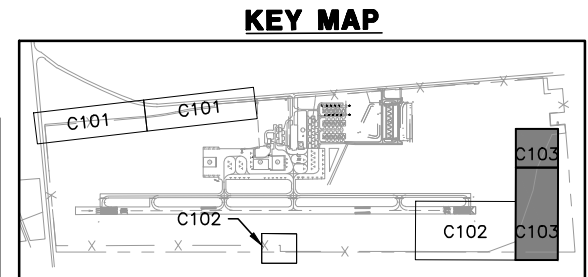

AUTH.	BY	DATE	REVISIONS
MIS	DAG	5/5/16	ADDENDUM NO. 2
<p>RS&H, Inc. 1715 N. Westshore Blvd., Suite 500 Tampa, FL 33609 Tel: 813-289-5555 Fax: 813-289-5555 www.rsandh.com E: info@rsandh.com FL EROSION0202 L0000210</p> <p>RS&H</p> <p>Tampa International Airport</p>			
PROJECT NAME	PERIMETER FENCE REHABILITATION		
PROJECT LOCATION	PLANT CITY AIRPORT, PLANT CITY, FL PETER O. KNIGHT AIRPORT, TAMPA, FL		
FAA NO.	NA		
HCAA NO.	6440 17		
JOB NO.	204-0001-032		
DESIGN	DAG		
DRAWN	SCS		
CHECKED	MIS		
FILE NAME	-		
SCALE:	AS SHOWN		
DATE:	MAY 8, 2017		
SHEET TITLE	FENCE PLAN - PCA AREA 2 (SHEET 2 OF 2)		
C103			

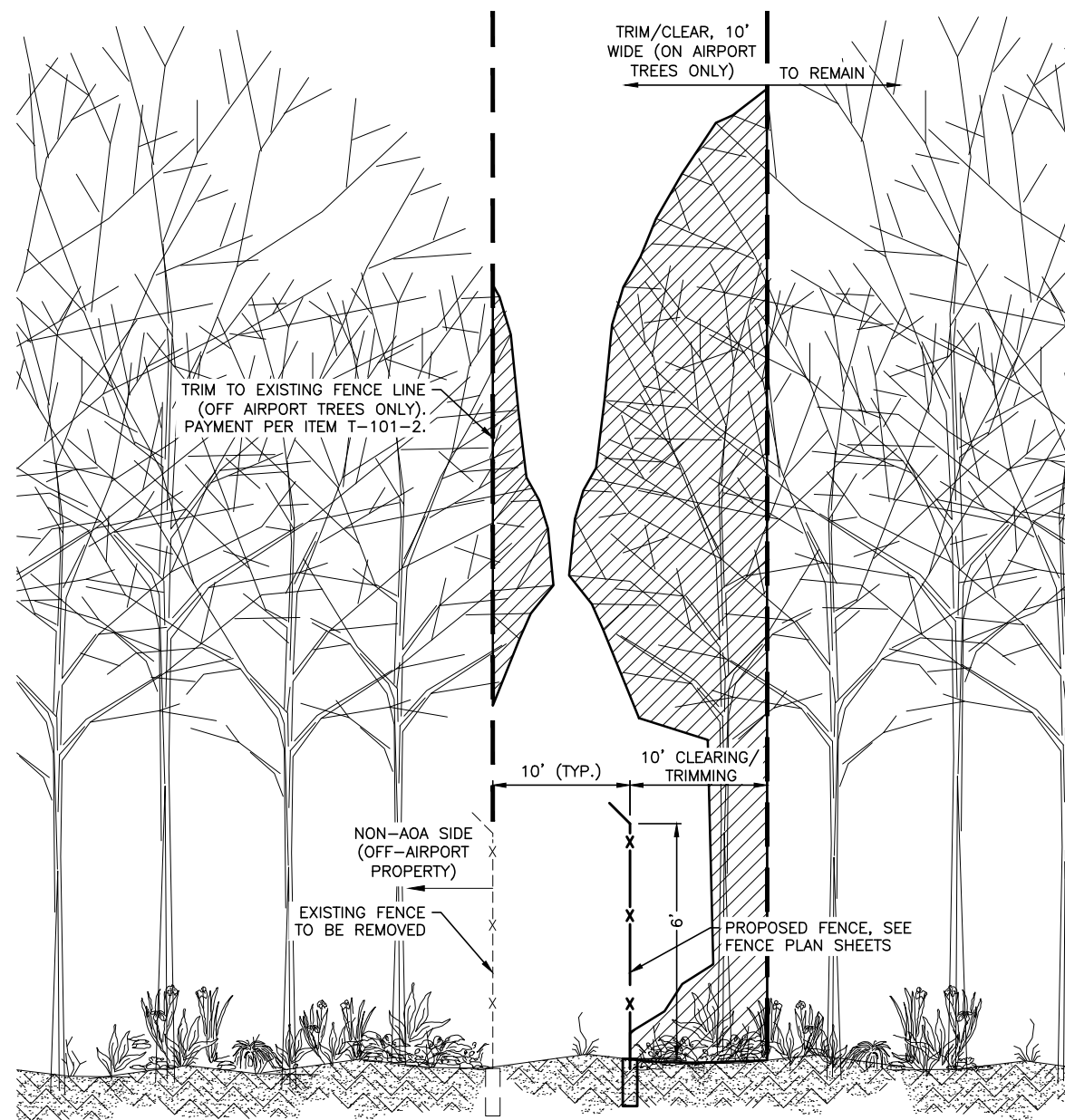

1 TREE CLEARING DETAIL - PCA AREA 1
 C301 SCALE: NTS

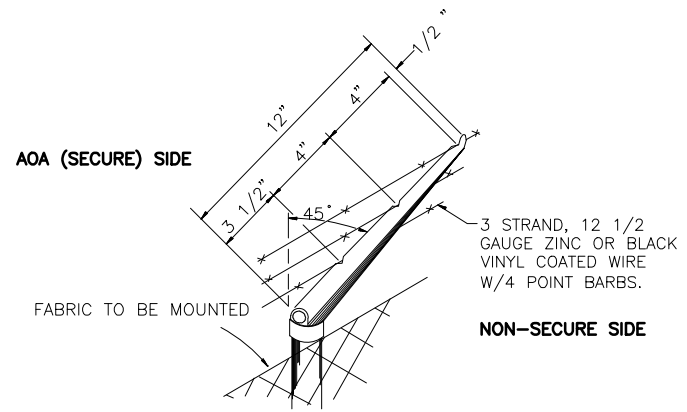

3 BARBED WIRE MOUNTING
 C301 SCALE: NTS

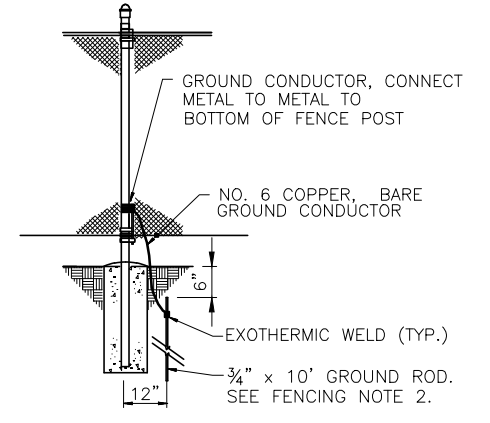

4 FENCE GROUNDING DETAIL
 C301 SCALE: NTS

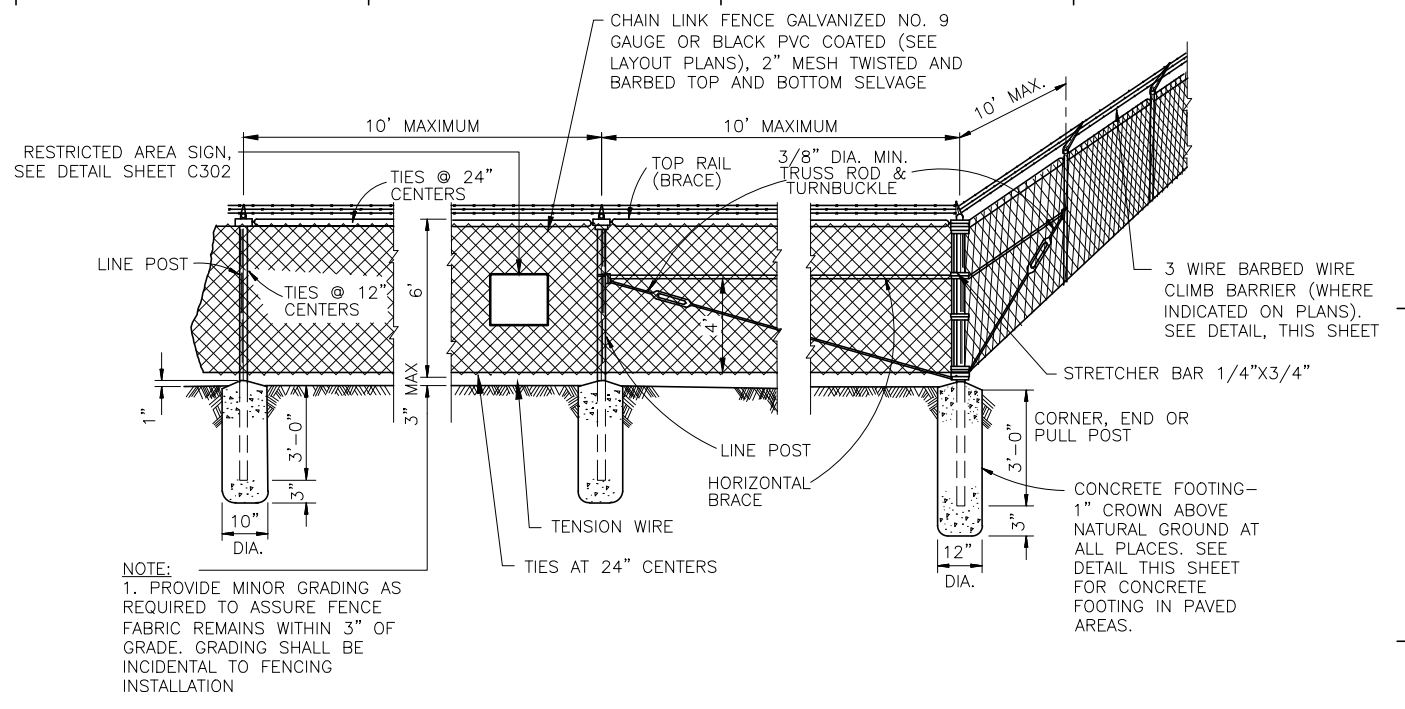

NOTE:
 1. PROVIDE MINOR GRADING AS REQUIRED TO ASSURE FENCE FABRIC REMAINS WITHIN 3" OF GRADE. GRADING SHALL BE INCIDENTAL TO FENCING INSTALLATION

LINE FENCING NOTES:

- PULL POSTS WITH APPROPRIATE DIAGONAL TRUSS RODS AND TURNBUCKLES SHALL BE INSTALLED EVERY 350' TO MAINTAIN TIGHT TENSION ON THE FABRIC AND BARBED WIRE.
- ELECTRICAL GROUNDS SHALL BE CONSTRUCTED AT 500' INTERVALS, AT POWER LINE CROSSINGS, AND AT EACH GATE POST.
- ALL REFERENCE TO THE TYPE OF COATING FOR ALL FENCE MATERIALS SHALL BE AS DEFINED IN THE F-162, CHAIN LINK FENCE, SPECIFICATION.
- FENCE POST CONCRETE FOOTINGS IN PAVED AND UNPAVED AREAS SHALL HAVE A MINIMUM COMPRESSIVE STRENGTH OF 2,500 PSI AT 28 DAYS.
- REFER TO PLANS FOR VARIATIONS IN FENCE COATING AND BARBED WIRE REQUIREMENTS.

2 LINE FENCING
 C301 SCALE: NTS

24' OPENING - TWO (2) EA 12' LEAFS
 12' OPENING - TWO (2) EA 6' LEAFS
 6' OPENING - ONE (1) EA SINGLE LEAF

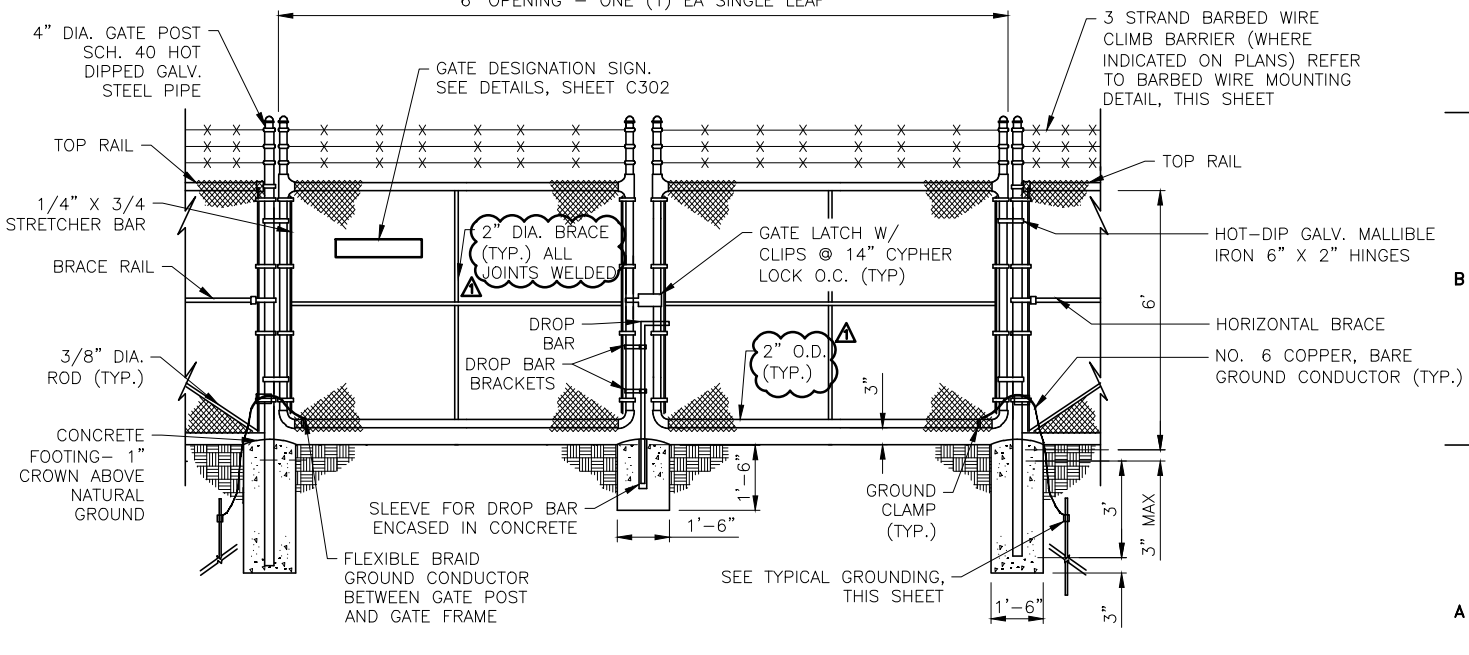

5 SWING GATE DETAIL
 C301 SCALE: NTS

AUTH. MIS BY: DAG DATE: 5/5/16 REVISIONS: A ADDENDUM NO. 2 DATE: 5/5/16 RSH, Inc. 1715 N. Westshore Blvd., Suite 500 Tampa, FL 33607 Phone: 813-989-5550 www.rsh.com FL ERO000267 ERO000267			PROJECT NAME: PERIMETER FENCE REHABILITATION PLANT CITY AIRPORT, PLANT CITY, FL PETER O. KNIGHT AIRPORT, TAMPA, FL F.A.A. NO. NA HCAA NO. 6440 17 JOB NO. 204-0001-032 DESIGN: DAG DRAWN: SCS CHECKED: MIS FILE NAME: SCALE: AS SHOWN DATE: MAY 8, 2017 SHEET TITLE: FENCE DETAILS (SHEET 1 OF 2)	C301
--	--	--	---	-------------

HILLSBOROUGH COUNTY AVIATION AUTHORITY

INVITATION TO BID

Sealed bids will be received from Bidders by the Hillsborough County Aviation Authority (Owner) in the Airport Administrative Offices Building, front office located on the Second Level, Red Side, Tampa International Airport, for the Project listed below, until **2:00 p.m., June 13, 2017**. All bids received will be publicly opened and read aloud thereafter in the Airport Administrative Offices Lobby Conference Room B, Second Level, Red Side. No bid will be considered unless received on or before the time and at the place designated above:

Airport Names: Peter O. Knight and Plant City Airports

Authority Project No.: 6440 17

Project Title: Perimeter Fence Rehabilitation

Project Description: This Project includes the removal and replacement of existing airfield security fences at Peter O. Knight and Plant City Airports.

Detailed Project Description: This Project consists of the removal of approximately 7,800 LF of galvanized chain link fence and replacement with black vinyl coated perimeter security fence at Peter O. Knight Airport. Also included at Peter O. Knight Airport is the installation of eight black vinyl coated chain link gates of various sizes and installation of new fence signage.

This Project also consists of removal and replacement of approximately 3,000 LF of galvanized and black vinyl coated perimeter security fence at Plant City Airport. Also included at Plant City Airport is the installation of one chain link gate, installation of new fence signage, tree and brush clearing and trimming along fence lines, and isolated regrading beneath existing fence.

Bidders are invited to submit bids for the work on the bid forms provided in the Contract Documents. Other bid forms will not be accepted.

Scheduled Item	Significant Dates
Contract Documents Available	May 8, 2017 by 5:00 p.m.
Deadline for on-line WebEx attendance registration for the Mandatory Pre-Bid Conference	May 12, 2017 by 1:30 p.m.
Mandatory Pre-Bid Conference	May 15, 2017 at 10:00 a.m.
Request for Clarification Deadline	May 30, 2017 by 2:00 p.m.
Addendum posted on Authority website	June 6, 2017 by 5:00 p.m.
Bid Submittal Time and Date	June 13, 2017 by 2:00 p.m.

TPF & PCM / PERIMETER FENCE REHABILITATION

A **MANDATORY** Pre-Bid Conference for all Bidders will be held in the Authority Boardroom, Main Terminal Building, Third Level, Blue Side, Tampa International Airport on **May 15, 2017 at 10:00 a.m.** Questions relating to the Contract and Contract Documents will be answered at that time. Attendance by all prospective Bidders is mandatory. Bids submitted by Bidders not in attendance at this scheduled MANDATORY Pre-Bid Conference will be rejected. **Attendance may be in person or via WebEx.** To be considered as attending in person, Bidder must have signed in on one of the sign-in sheets. Attendees are warned that the sign-in sheets will be collected once the Pre-Bid Conference begins. Any Attendees arriving late after the sign-in sheets are collected will not be considered to have attended the Pre-Bid Conference as required. **Contact the Procurement Agent listed below (Page 00020-3) via email to register as an on-line attendee by WebEx. To be considered as attending via WebEx, the attendee must be identified by the Procurement Agent at the start of the Pre-Bid Conference and must stay on-line through the end of the Pre-Bid Conference. The on-line attendance registration deadline is listed above. Pre-registration is not required for in person attendees.**

A **NON-MANDATORY** site inspection of the Project areas at Peter O. Knight and Plant City Airports will occur as a part of the scheduled Pre-Bid Conference. Details will be announced during the Pre-Bid Conference.

IMPORTANT NOTICE

All Bidders are hereby notified that they must comply with the Woman and Minority Business Enterprise (W/MBE) Program requirements as defined in the Owner's W/MBE Policy.

W/MBE – This Project has no federal funding and has a W/MBE Goal of 0%.

Complete examination and understanding of the Contract Documents, including the bidding documents, general conditions of the Contract, specifications, construction drawings and the site of the proposed work, are necessary to properly submit a bid.

To download Contract Documents, fill out the form on the "Request to Download Contract Documents" link on the Authority's website. This form must be completed and submitted in order to download the Contract Documents. Contract Documents will be available for downloading on the date and time as listed on Page 00020-1.

A cashier's check on any national or state bank or a bid bond on the form contained in the Contract Documents in an amount not less than 5% of the total amount bid, made payable to the Hillsborough County Aviation Authority, must accompany each bid as a guarantee that the Bidder will not withdraw its bid for a period of 85 calendar days (or 115 calendar days if federal funds are applicable) after opening of the bids, and as a guarantee that, in the event the Contract is awarded to the Bidder, Bidder will, within seven days after the date of award of the Contract, enter into a Contract with the Owner and furnish the required and executed contracts, insurance policy endorsements, certificates of insurance and performance and payment bonds. If Bidder fails to do this, Bidder will forfeit the amount of the cashier's check or bid bond as liquidated damages. The Bidder agrees that these liquidated damages are not a penalty. The bid bond and performance and payment bonds are required to be secured by an agency of the surety, which agency will have an established place of business in the State of Florida and will be duly licensed to conduct business therein.

Each bid and any attachments submitted will be placed in an opaque, sealed envelope plainly marked on the outside with:

"Bid for:

Perimeter Fence Rehabilitation
Authority Project No. 6440 17
Peter O. Knight and Plant City Airports

and with the name and address of the Bidder. Each bid will be delivered to the Owner or mailed to the Owner at Hillsborough County Aviation Authority, P. O. Box 22287, Tampa, Florida 33622, at the time and place stated on Page 00020-1.

The physical address of the Owner for overnight delivery, courier or express services is Hillsborough County Aviation Authority, Tampa International Airport, 4160 George J. Bean Parkway, Suite 2400, Administrative Building, Second Level, Red Side, Tampa, Florida 33607.

If mailed, the bid will be sent by certified/registered mail, with return receipt requested.

The Bidder must supply all information required by the bid form, Contract Documents and required attachments.

The Owner reserves the right to waive any formalities, technicalities, or irregularities, and reject any or all bids, re-advertise for bids and avoid or refrain from awarding the contract for the work.

If you have any questions pertaining to this Project, please contact the Procurement Agent, Joe Benjamin, at (813) 8071-6082 or email at JBenjamin@TampaAirport.com.

END OF SECTION

SECTION 00100 - INSTRUCTIONS TO BIDDERS

1.01 GENERAL

- A. This Contract is to be financed solely by the Hillsborough County Aviation Authority (Owner). Award of Contract is subject to the approval of the Owner.
- B. Owner, in accordance with the provisions of Title VI of the Civil Rights Act of 1964 (78 Stat. 252, 42 U.S.C. §§2000d to 2000d-4) and the Regulations, hereby notifies all bidders that it will affirmatively ensure that in any contract entered into pursuant to this advertisement, disadvantaged business enterprises and airport concession disadvantaged business enterprises will be afforded full and fair opportunity to submit bids in response to this invitation and will not be discriminated against on the grounds of race, color, or national origin in consideration for an award.
- C. Non-Discrimination and Segregated Facilities:
 1. Each Bidder will complete, sign and include in their Bid the Certification of Non-Segregated Facilities. If not submitted with the Bid, the Bid may be considered irregular and may be rejected. When a determination has been made to award a Contract to a specific Contractor, such Contractor will, prior to award, furnish such other pertinent information regarding compliance with Federal Regulation and Contractor's own employment policies and practices as the Federal Aviation Administration, the Owner, or the Secretary of the Labor Office of Federal Contract Compliance (OFCC) may require. Contractor will require similar compliance with its subcontractors. Where the Contract Price is \$10,000.00 or greater, Contractor will comply with Part 152 of the Federal Aviation Regulations as amended and specifically FAR 152.411 (c) and (d), incorporated herein by this reference. All such information required of a subcontractor will be furnished by the Contractor.
 2. The Equal Employment Opportunity Report Statement, Certificate of Non-Segregated Facilities, Equal Opportunity Clause, and all other EEO requirements will be included in all non-exempt subcontracts entered into by the Contractor. Subcontracts entered into by Contractor will also include all other applicable labor provisions. No subcontract will be awarded to a non-complying subcontractor.
 3. Affirmative Action: If the Contract is an Aviation Related Activity as defined in 14 CFR Part 152, and is a Construction Contract of \$10,000.00 or more, Contractor assures that it will undertake an Affirmative Action Program as required by 14 CFR Part 152 Subpart E, to insure that no person will, on the grounds of race, creed, color, national origin, or sex, be excluded from participating in or receiving the services or benefits of any program or activity covered by this Subpart. Contractor assures that it will require that its covered suborganizations provide assurances to the Contractor that they similarly will undertake Affirmative Action Programs and that they will require assurances from their suborganizations, as required by 14 CFR Part 152, Subpart E to the same effect.

4. In addition, the Bidder will also insert in each of Bidder's subcontracts a clause requiring the subcontractor to include these provisions in any lower tier subcontracts which they may enter into, together with a clause requiring this insertion in any further subcontracts that may in turn be made.

D. Compliance with Governmental Requirements:

1. The Bidder covenants and agrees that Bidder and Bidder's agents and employees will comply fully with all applicable federal, state, county, municipal or other governmental laws, executive orders, wage, hour and labor, equal employment opportunity, Woman and Minority Owned Business Enterprises, pollution control, and environmental regulations, applicable national and local codes, and Hillsborough County Aviation Authority Rules and Regulations, and that Bidder will obtain all necessary permits, pay all required fees and taxes, and otherwise perform these services in a legal manner. To the maximum extent permitted by applicable law, the Bidder will indemnify and hold harmless the Owner, its Board members, officers, employees, agents, and volunteers from any fees, damages, fines or costs of any kind arising out of Bidder's or any of the Bidder's consultants, subcontractors, suppliers or agents of any tier or their respective employees' failure to comply with such governmental regulations. This obligation to indemnify and hold harmless will be construed separately and independently. If this clause is found to be in conflict with applicable law, the clause will be considered modified by such laws to the extent necessary to remedy the conflict.
2. Bidder certifies that all materials, equipment, etc., contained in their Bid meets all OSHA requirements.
3. Bidders must comply with the Fair Labor Standards Act.
4. It is the Authority's policy to promptly take any measures necessary to ensure that no person in the United States shall, on the grounds of race, creed, color, national origin, sex, age, or disability be excluded from participation in, be denied the benefits of, or be otherwise subjected to discrimination in any activity conducted with, or benefiting from, funds received from this Procurement. Bidder agrees to abide by this Policy.
 - a. Using the definitions of activity, facility and program as found and defined in §§21.23(b) and 21.23(e) of 49 CFR §21, the Authority and Bidder will facilitate all programs, operate all facilities, or conduct all programs in compliance with all non-discrimination requirements imposed by, or pursuant to FAA Grant Assurance 30.

E. Procurement Protest Policy:

1. Failure to follow the procurement protest policy set out in the Owner's policies constitutes a waiver of Bidder's protest and resulting claims. A copy of the procurement protest policy may be obtained by contacting the Owner via telephone at 813-870-8700 or via mail to Hillsborough County Aviation Authority, Post Office Box 22287, Tampa, Florida 33622. The policy is also available on the Owner's website: www.TampaAirport.com > Learn about TPA >

Airport Business > Procurement > Procurement Protest Policy. The Authority will post on its website, and make available for public access, any and all formal protest documents received on this solicitation.

F. Public Entity Crime Convicted Vendor List:

By submitting a Bid, Bidder represents that it is not precluded from submitting a Bid under Section 287.133(2)(a), Florida Statutes, which provides as follows: a person or affiliate who has been placed on the convicted vendor list following a conviction for a public entity crime may not submit a bid on a contract to provide any goods or services to a public entity, may not submit a bid on a contract with a public entity for the construction or repair of a public building or public work, may not submit bids on leases of real property to a public entity, may not be awarded or perform work as a contractor, supplier, subcontractor, or consultant under a contract with any public entity, and may not transact business with any public entity in excess of the threshold amount provided in Section 287.017, Florida Statutes for CATEGORY TWO for a period of 36 months from the date of being placed on the convicted vendor list.

G. General Bond Requirements:

1. The bid security will be as specified; only the Bid Bond and Surety's Bond Affidavit as bound within these documents or a Cashier's Check is acceptable. Each separate Bid will be accompanied by a Cashier's Check or Bid Bond on the form provided herein in an amount of not less than 5% of the total amount bid, made payable to the Hillsborough County Aviation Authority. If a Bid Bond is provided in lieu of a Cashier's Check, it must be accompanied by a valid Power of Attorney indicating that the person signing the Bond on behalf of the Surety has full legal authority to do so. Failure to provide the Bid Bond or Cashier's check will result in your bid being found as non-responsive. If the Power of Attorney is not provided with the Bid Bond, the Bid may be considered irregular and may be rejected.
2. The amount of such Bid Bond or the Cashier's Check of the Bidder whose Bid is accepted will be forfeited and paid to the Owner as liquidated damages if said Bidder fails to enter into a Contract with the Owner and fails to furnish the required and executed contracts, certificates of insurance and performance and payment bonds within seven days after the date of the award of the Contract. The Bidder agrees that the liquidated damages are not a penalty and 5% of the total bid amount is reasonable.
3. Contract Payment and Performance Bonds will be as specified; only the Payment and Performance Bonds and Surety's Bond Affidavits as bound within these Contract Documents are acceptable.
4. The Surety of the Bond will be a corporate Surety authorized under the laws of Florida to do business in Florida, and authorized to write that type of bond through a licensed agent of the Surety located in Florida. The agent authorized to represent the Surety on the Bid Bond must be listed on the State website: www.myfloridacfo.com. If the agent is not listed on the State website as an authorized representative of the Surety, the Bid may be considered irregular and

may be rejected.

H. Insurance Requirements:

Insurance requirements will be as specified herein in Section 00650 - INSURANCE REQUIREMENTS.

1.02 EXAMINATION OF CONDITIONS AFFECTING WORK

- A. Prior to submitting a Bid, each Bidder will examine and thoroughly familiarize itself with all existing conditions, including all applicable laws, codes, ordinances, rules and regulations that will affect their Work. Bidders will visit the Project Site, examine the grounds and all existing buildings, utilities, pavements and systems and will ascertain all conditions that will in any manner affect Work. Bidders will make a request to the Owner, in writing, for any additional information deemed necessary for Bidder to be fully informed as to exactly what is to be expected prior to submitting a Bid.
- B. The Owner will make available during normal business hours, at its offices, Record Documents and Drawings pertaining to the existing Site and Facilities at the Airport listed on Section 00020 - INVITATION TO BID, Page 00020-1. These Record Documents and Drawings will not be considered a part of the Contract Documents but are provided by the Owner for information only to assist Bidders in ascertaining conditions that may affect the Work. Record Documents and Drawings have been maintained by the Owner solely for the Owner's own benefit, and do not necessarily indicate all existing conditions fully or accurately. Bidders will be solely responsible for all assumptions made in reliance upon Record Documents and Drawings.
- C. The Contract Documents describe the Work to be performed under this Contract and include, but are not limited to, the Bidding Documents, Bonds, Affidavits, Compliance Forms, Statements, Insurance Requirements and Documents, the Contract between Owner and Contractor (herein referred to as the Contract), Conditions of the Contract (General Conditions), General Requirements and other Requirements, Reports, and Specifications.
- D. The Bidders shall be responsible for obtaining any and all information that they consider necessary for the purpose of preparing and submitting their Bid.
- E. By submitting a Bid, Bidder certifies that it has investigated and is fully informed of the conditions to be encountered, of the character, quality and quantities of Work to be performed and materials to be furnished, and it has included in its Bid all items and costs necessary for the proper execution and completion of the Work.

1.03 CONE OF SILENCE AND INTERPRETATIONS

The Owner has established a cone of silence applicable to all competitive procurement processes, including this Bid. The cone of silence will be imposed beginning with the advertisement for this Bid and will end upon the Board's award of the Bid.

- A. The cone of silence prohibits any communications regarding this Invitation to Bid between:

1. A potential respondent (which includes vendors, service providers, bidders, proposers, lobbyists and consultants) and their representative(s) and Owner's staff, except for communications with the Owner's procurement agent or other supporting procurement staff responsible for administering the procurement, provided the communication is strictly limited to procedural matters; and
 2. A potential respondent and their representative(s) and a Board member.
- B. Unless specifically provided otherwise, in addition to the exceptions set forth above, the cone of silence does not apply to:
1. Communications with the Owner's Legal Affairs Department; and
 2. Oral communications at the Pre-Bid Conference; and
 3. Oral communications during any duly noticed Board meeting; and
 4. Communications relating to protests made in accordance with the Owner's Procurement Protest Policy.
- C. Any communications regarding matters of process or procedure from a potential Bidder must be referred to the Procurement Agent listed in Section 00020 – INVITATION TO BID, Page 00020-3. Please refer to the Owner's website at www.TampaAirport.com > Learn about TPA > Airport Business > Procurement > Current Solicitation Opportunities for updated information pertaining to any addenda or revisions to the Bid schedule.
- D. No oral interpretation or clarification of the Contract Documents will be made to any Bidder. If Bidder requires clarification or finds any ambiguities, discrepancies in, or omissions or there is doubt as to the true meaning of any part of the Contract Documents, a written request for clarification or interpretation must be submitted to the Procurement Agent listed in Section 00020 – INVITATION TO BID, Page 00020-3.
- E. All such interpretations and any supplemental instructions will be in the form of a written addendum posted on the Owner's website at www.TampaAirport.com > Learn about TPA > Airport Business > Procurement > Current Solicitation Opportunities. It is the responsibility of the Bidder to verify the Owner received their request by contacting the Procurement Agent listed in Section 00020 – INVITATION TO BID, Page 00020-3. Failure of any Bidder to review any addendum will not relieve them from any obligation contained therein.
- F. The Owner will notify prospective Bidders of any changes by posting the addenda on the Owner's website.
- G. Any violation of the cone of silence will render voidable the bid, as well as the awarded Contract.

1.04 SUBSTITUTIONS

- A. The materials, products and equipment described in the Contract Documents establish a

standard of required function, dimension, appearance and quality to be met by any proposed substitution. The Contractor is responsible for assuring that all suppliers, subcontractors and vendors conform to the Contract requirements.

- B. No substitution will be considered prior to the specified Bid submittal time and date unless written request for approval has been submitted in the proper format as a Request for Clarification. The burden of proof on the merit for the proposed substitution is upon the Bidder. The Owner's decision to approve or disapprove a proposed substitution is final.
 - 1. In making requests for substitutions, the Bidder will list the particular system, product, or material Bidder wishes to substitute, and the justification for the substitution. Requests submitted will include any and all adjustments of that and any other Work affected thereby.
- C. If the Owner approves a proposed substitution prior to the specified Bid submittal time and date, such approval will be set forth in an Addenda. Bidders will not rely on approvals made in any other manner.
- D. No substitutions will be considered after the Bid submittal time and date except as specifically provided for in the Contract Documents.

1.05 ADDENDA

- A. Any Addenda issued by the Owner prior to the Bid submittal time and date for the purpose of changing the intent of the Contract Documents or clarifying the meaning of same, will be binding in the same way as if written in the Contract Documents. Since all Addenda are available to Bidders on the Owner's website, it is each Bidder's responsibility to check with the Procurement Department and immediately secure all Addenda before submitting Bids. It is the usual practice for the Owner to e-mail Addenda to known Bidders, but it cannot be guaranteed that all Bidders will receive Addenda in this manner. Each Bidder will acknowledge receipt of each and every Addendum by notation on the Bid Form. If acknowledgment is not given on the Bid Form, the Bid may be considered irregular and may be rejected.
- B. Request for Clarifications are due on the date listed in Section 00020 - INVITATION TO BID, PAGE 00020-1. If addenda are to be issued, they will be posted on www.TampaAirport.com > Learn about TPA > Airport Business > Procurement > Current Solicitation Opportunities on the date listed in Section 00020 – INVITATION TO BID, Page 00020-1.
- C. Any issue that may affect Bidder's ability to bid or to construct the Project may be submitted to the Procurement Agent after the Request for Clarification Deadline. The Owner will determine if the issue affects the Bidder's ability to bid or construct the Project and, if it substantially does so, will issue an Addendum addressing the issue.

1.06 CONTRACT DOCUMENTS

- A. Complete sets of the Contract Documents can be obtained from the Owner as designated in Section 00020 - INVITATION TO BID.

- B. Bidders are expected to use complete sets of Contract Documents in preparing Bids. Bidder shall be solely responsible and liable for errors or misinterpretations resulting from the use of incomplete sets of Contract Documents.
- C. If Bidder has any questions or finds ambiguities, discrepancies in, or omissions from the Contract Documents, the Bidder shall promptly notify the Owner by submitting a Request for Clarification.
- D. By submitting a Bid, the Bidder certifies that it has thoroughly and fully examined the Contract Documents and that it has informed the Owner of any questions, ambiguities, discrepancies in, or omissions from the Contract Documents.

1.07 ISSUANCE OF BID FORMS

- A. The Owner reserves the right to refuse to issue the Contract Documents and Bid Form to a prospective Bidder should such Bidder be determined by the Owner to be non-responsible. Among the criteria which the Owner may use in making such determination are the following:
 - 1. Failure to comply with any qualification requirements of the Owner, including failure to supply such information as the Owner may require in evaluating the qualifications of Bidders or failure to supply the Owner with such documents or information as the Owner may request to assist the Owner in evaluating the responsibility of prospective Bidders.
 - 2. Past performance of the Bidder or any affiliated or related entity.
 - 3. Failure of the Bidder or any affiliated or related entity to pay or satisfactorily settle all bills for labor and material on any former contract with the Owner.
 - 4. The outstanding obligations of the Bidder, whether previously assumed or to be assumed in the future.
 - 5. Unsatisfactory, defective, or non-conforming work on any previous contract with the Owner by the Bidder or any affiliated or related entity.
 - 6. The present relationship between the Owner and the Bidder (or any affiliated or related entity), including the existence of any unresolved disputes arising out of past projects.
- B. The issuance of the Contract Documents and Bid Form to a particular Bidder will not prevent or preclude the Owner from determining at a later date that a particular Bidder or entity is non-responsible. The Owner at all times reserves the right to refrain from issuing the Contract Documents or awarding this Contract to a non-responsible entity or to any affiliated or related entity, including the Owner of any non-responsible entity and subsidiaries of such Owner, as well as any successor, assignee, transferee or majority interest holder of any non-responsible entity.

1.08 RESPONSIBILITY OF BIDDERS

- A. The Owner reserves the right to investigate and determine the responsibility of the Bidders before and after Bids are received. Owner will not award the Contract to any Bidder determined by Owner to be non-responsible. Among the criteria which Owner may use in making such determination are the following:
1. Failure to comply with any qualification requirements of the Owner, including failure to supply such accurate information as the Owner may require in evaluating the responsibility of Bidders or failure to supply the Owner with such documents or information as the Owner may request to assist the Owner in evaluating the responsibility of prospective Bidders.
 2. Failure of the Bidder to obtain proper license (if any is required) prior to bidding, i.e. if Bidder is not certified and licensed in accordance with the appropriate State of Florida Statutes and appropriate State of Florida construction or professional licensing boards, including but not limited to the requirements of Chapters 255 and 287 of the Florida Statutes. In addition, applicable license(s) must be current and active throughout the life of the project.
 3. Past performance of the Bidder, one or more of the listed Subcontractors or any affiliated or related entity.
 4. Failure of Bidder or any affiliated related entity to pay or satisfactorily settle all bills for labor and materials on any former contract with Owner.
 5. The outstanding obligations of the Bidder, whether previously assumed or to be assumed in the future.
 6. Unsatisfactory, defective, or non-conforming work on any previous contract with the Owner by the Bidder, one or more of the listed subcontractors, or any affiliated or related entity.
 7. The present relationship between the Owner and the Bidder (or any affiliated or related entity), including the existence of any unresolved disputes arising out of past projects.
 8. The financial condition of the Bidder. Such evidence of financial responsibility will consist of a confidential statement or report of the Bidder's financial resources and liabilities as of the last calendar year or the Bidder's last fiscal year. Such statements or reports will be certified by a public accountant. At the time of submitting such financial statements or reports, the Bidder will further certify whether their financial responsibility is approximately the same as stated or reported by the public accountant. If the Bidder's financial responsibility has changed, the Bidder will qualify the public accountant's statement or report to reflect the Bidder's true financial condition at the time such qualified statement or report is submitted to the Owner.
 9. Experience of the Bidder and/or its listed subcontractors in performing Work of this nature.

10. Submission of appropriate Women and Minority Owned Business Enterprise (W/MBE) information.
11. Past compliance with the Owner's W/MBE Policy and Program on Owner projects only.
12. Submission, upon request, of the Bid Documents.
13. Bidders, subcontractors or material suppliers listed on the State or Federal convicted list or FDOT Suspension list.
14. Lack of Competency of Bidder. The Contract will be awarded only to a Bidder considered to be capable of performing the Work as required by the Contract Documents. Owner may declare any Bidder ineligible at any time during the process of receiving bids or awarding the Contract where developments arise which, in the opinion of the Owner, adversely affect the Bidder's competency to perform the Work and to discharge its responsibilities under the Contract.
15. If Bidder is not registered with the Florida Division of Corporations and authorized to do business in Florida.
16. If Bidder is listed on any of the following lists:
 - a. State Convicted Vendor List.
 - b. Federal Convicted Vendor List.
 - c. FDOT Suspension List
 - d. Scrutinized Companies with Activities in Sudan List or Scrutinized Companies with Activities in the Iran Petroleum Energy Sector.
17. Failure to register with the Owner as a Supplier (www.TampaAirport.com >Learn about TPA > Business Opportunities > Procurement > Supplier Registration). For general questions concerning the Supplier Registration process call 813-870-8796.

1.09 PREPARATION AND SUBMISSION OF BID

- A. Sealed Bids for the construction of the Work generally described will be received until the time and date stated in the Section 00020 - INVITATION TO BID.
- B. Bids received without Section 00300 – BID FORM will be found non-responsive.
- C. Bids received without Section 00340 – BID SCHEDULE will be found non-responsive.
- D. Bids received without Section 00350 – BID AFFIDAVIT may be considered irregular and may be rejected.
- E. Bids received without Section 00400-1 – Bid Bond or a Cashier's Check will be found

non-responsive. Bids received without Section 00400-2 –SURETY BOND AFFIDAVIT may be considered irregular and may be rejected.

- F. Bids received without Section 00417 – WOMAN AND MINORITY OWNED BUSINESS ENTERPRISE ASSURANCE AND PARTICIPATION may be considered irregular and may be rejected
- G. Bids received without Section 00418 – CERTIFICATE OF NON-SEGREGATED FACILITIES may be considered irregular and may be rejected.
- H. Bids received without Section 00420 – BIDDER’S GENERAL BUSINESS INFORMATION may be considered irregular and may be rejected.
- I. Bids received without Section 00421 – SCRUTINIZED COMPANY CERTIFICATION may be considered irregular and may be rejected.
- J. Bids received without Section 00422 - E-VERIFY CERTIFICATION may be considered irregular and may be rejected.
- K. Bids received without Section 00423 - NON-COLLUSION CERTIFICATION may be considered irregular and may be rejected.
- L. Bids received without Section 00430 – SUBCONTRACTORS LIST may be considered irregular and may be rejected.
- M. Bids received without Section 00440 – BIDDER’S SELECTION OF PAYMENT METHOD may be considered irregular and may be rejected.
- N. Bids received without the Financial Statement may be considered irregular and may be rejected.
- O. Bids received without a copy of a current and active Contractor’s License that qualifies the company to bid on the work may be considered irregular and may be rejected.
- P. Each bid submitted will include one set of signed originals of all the items listed in Paragraph R of this Section with the exception of those marked with an asterisk.
- Q. Due to the allocation of funds, successful Bidders will be required to provide a Schedule of Values in a manner acceptable to the Design Professional and Owner, and in accordance with the Contract Documents.
- R. Each Bid and any attachments submitted will be placed in a sealed opaque envelope plainly marked on the outside with:

“Bid for:

Perimeter Fence Rehabilitation
Authority Project No. 6440 17
Peter O. Knight and Plant City Airports”

When sent by mail, certified/registered, the sealed Bid, marked as indicated above, should be enclosed in an additional envelope. No Bid will be considered unless received at the place specified in the Contract Documents before the Bid submittal time and date specified for opening all Bids. Bids received after the specified Bid submittal time and date will be returned to the Bidder unopened.

The envelope will contain one set of signed originals of the following documents except those with an asterisk. Those documents with an asterisk may have copies of the completed, signed originals submitted.

SECTION	TITLE
00300	BID FORM
00340	BID SCHEDULE
00350	BID AFFIDAVIT
00400-1	BID BOND or (Cashier's Check)
00400-2	SURETY BOND AFFIDAVIT
00417*	WOMAN AND MINORITY OWNED BUSINESS ENTERPRISE ASSURANCE AND PARTICIPATION
00418	CERTIFICATE OF NON-SEGREGATED FACILITIES
00420	BIDDER'S GENERAL BUSINESS INFORMATION
00421	SCRUTINIZED COMPANY CERTIFICATION
00422	E-VERIFY CERTIFICATION
00423	NON-COLLUSION CERTIFICATION
00430	SUBCONTRACTORS LIST
00440	BIDDER'S SELECTION OF PAYMENT METHOD
- - -	COPY OF FINANCIAL STATEMENT
- - -	COPY OF CONTRACTORS LICENSE (CURRENT & ACTIVE) THAT QUALIFIES THE COMPANY TO BID ON THIS WORK

- S. The Bidder will have downloaded Contract Documents from the Owner and must submit their Bid on the forms furnished by the Owner in the Contract Documents. Bids submitted by Bidders who have not downloaded Contract Documents from the Owner's website may be rejected. All blank spaces in the Bid forms must be correctly filled in where indicated and the Bidder must state the price(s) (written in ink) both in words and numerals. The words, unless obviously incorrect, will govern.

- T. Bids will be submitted as indicated in Section 00300 - BID FORM and will be signed in ink by an official of the firm submitting the Bid. If Section 00300 - BID FORM is not submitted with the Bid, the Bid will be found non-responsive.
- U. Erasures or other changes in a Bid will be explained or noted over the signature of the Bidder.
- V. Bids containing reservations, conditions, omissions, unexplained erasures or alterations, items not required in the Bid or irregularities of any kind may be rejected by the Owner.
- W. Each Bid will indicate the full business name and address of the Bidder and will be signed by Bidder with Bidder's usual signature.
- X. A Bid submitted by a partnership will list the names of all partners and will be signed in the partnership name by one of the members of the partnership.
- Y. A Bid submitted by a corporation will be executed in the legal name of the corporation. If the Bid Affidavit is signed by a person other than the President or Vice President of the corporation, such person must furnish a corporate resolution showing their authority to bind the corporation. The name of each person signing the Bid will be typed or printed below the signature.
- Z. When requested by the Owner, a Power of Attorney or other satisfactory evidence of the authority of the officer signing in behalf of the corporation will be furnished for the Owner's records.
- AA. The Bid will be accompanied by a Bid Bond and Surety's Bond Affidavit executed on the forms provided or a Cashier's Check payable to the Owner, in an amount not less than 5% of the bid amount. If a Bidder withdraws its Bid within 85 calendar days (or 115 calendar days if federal funds are applicable) from the date on which Bids are opened, or if a Bidder is awarded the Contract but fails, refuses or neglects to execute and return the Contract or to furnish acceptable Insurance Documents and the required Certificates of Insurance, Payment and Performance Bonds within seven calendar days after the date of award of the Contract, then the amount of the Bond or cashier's check will be paid to, or retained by, the Owner as liquidated damages. The Bidder agrees that the Liquidated Damages are not a penalty and 5% of the total bid amount is reasonable.
- BB. When sent by mail, the sealed Bid, marked as indicated in this Section, will be enclosed in an additional envelope and sent by certified/registered mail with return receipt requested. No Bid will be considered unless received on or before the time and at the place designated in the INVITATION TO BID. The Owner will in no way be responsible for delays caused by the U.S. Postal Service or any other deliverer of the Bid, or for delay caused by any other occurrence.
- CC. The Bidder will supply all information required by the Bid Form and Contract Documents.

1.10 MODIFICATIONS OR WITHDRAWAL OF BIDS

- A. A Bidder may withdraw and resubmit a Bid, provided that Bidder's request for withdrawal is received by the Owner in writing before the time specified for submittal of Bids. Revised Bids must be received at the place specified in the Contract Documents before the time and date specified for submittal of Bids. Modifications will not reveal original amount of bids. Bid Bonds must reflect modifications.
- B. Negligence on the part of the Bidder in the preparation of their Bid will not be grounds for modification or withdrawal of the Bid after the Bid Submittal time and date.

1.11 PUBLIC OPENING OF BIDS

- A. Bids will be opened and read publicly at the time and place specified in the Contract Documents. Bidders, their authorized agents, and other interested persons are invited to attend.
- B. Bids that have been withdrawn (by written or e-mail request) or received after the time and date specified for submittal of Bids will be returned to the Bidder unopened.
- C. Owner reserves the right to correct, in all Bids, obvious mathematical or transposition errors within the Bid Prices or Total Bid Price, as long as the intent of the Bidder is reasonably clear from the Bid.
- D. All Bids and other materials or documents submitted by a Bidder for this Project will become property of the Owner. The Owner is subject to the public records requirements of Florida State Statute Chapter 119, and as such, all materials submitted by the Bidder to the Owner are subject to public disclosure. The Bidder specifically waives any claims against the Owner related to the disclosure of any materials if made under a public records request.

1.12 REJECTION OF BIDS

- A. Bids containing any omission, alterations of form, additions or conditions not called for, conditional or alternate bids unless called for, incomplete bids, or Bids otherwise regular which are not accompanied by a Cashier's Check or Bid Bond may be considered irregular and may be rejected.
- B. The Owner reserves the right, in Owner's judgment and sole discretion, to reject any or all Bids, to waive any formalities, technicalities or irregularities therein, to avoid or refrain from awarding a contract for Work, and to re-advertise for Bids.
- C. Bids may be considered irregular for the following reasons:
 - 1. If the Bid is on a form other than that furnished by the Owner, or if the Owner's form is altered.
 - 2. If there are unauthorized additions, conditional or alternative pay items, or irregularities of any kind which made the Bid incomplete, indefinite or otherwise ambiguous.
 - 3. If the Bid is not accompanied by all the Documents listed in Item 1.09 R.

4. Submitting more than one Bid from the same partnership, firm or corporation under the same or different name.
 5. Evidence of collusion among Bidders. Bidders participating or previously participating in such collusion will be disqualified as Bidders for this and any future work of the Owner until any such participating Bidder has been reinstated by Owner as a qualified Bidder.
 6. Evidence that Bidder has a financial interest in the firm of another Bidder for the same Work.
 7. If the Bidder, employee or agent of the Bidder has a Conflict of Interest as determined by the Director of Procurement.
 8. If Bidder is considered to be "non-responsible" for any reason specified in Item 1.08-RESPONSIBILITY OF BIDDERS of this Section.
- D. Bids will be considered non-responsive for the following reasons:
1. If the bid is not accompanied by Section 00340-BID SCHEDULE or Section 00400-1-BID BOND.
 2. Bids received that do not meet the requirements specified in Section 1.14 - WOMAN AND MINORITY OWNED BUSINESS ENTERPRISE (W/MBE) POLICY AND PROGRAM.
 3. If Bidder cannot demonstrate ability to obtain Contract required insurance specified in Section 00650 – INSURANCE REQUIREMENTS.
- E. The Owner reserves the right to reject any and all Bids for any reason including but not limited to that the Bid is higher than the Owner approved budget or estimated project cost.

1.13 ESCROW OF BID DOCUMENTS

- A. Each Bidder agrees that all documents relied upon in making or supporting their Bid will be retained in escrow, in a manner satisfactory to the Owner, prior to the date the Contract is awarded and preserved and maintained during the course of the Work until Final Payment is made. The Owner will have the right to inspect any and all such Bid Documents and to verify that such Bid Documents are properly escrowed prior to the time of the Award of the Contract, or at any time thereafter during the course of the Work.

1.14 WOMAN AND MINORITY OWNED BUSINESS ENTERPRISE (W/MBE) POLICY AND PROGRAM

- A. Policy: It is the policy of the Owner that W/MBE as defined herein will have full and fair opportunities to compete for and participate in the performance of all non-federally funded contracts or in the purchase of goods and services procured by the Owner and the Bidder will take all necessary and reasonable steps to ensure that W/MBEs have full

and fair opportunities to compete for and perform subcontracts. Bidders will demonstrate that they will subcontract with certified W/MBEs, or clearly demonstrate in a manner acceptable to the Owner its good faith efforts to obtain W/MBE subcontractors. The successful bidder's W/MBE commitment as stated on their Letter(s) of Intent will be enforceable under the terms of the contract.

A business certified as a W/MBE by Hillsborough County, City of Tampa, State of Florida Office of Supplier Diversity (OSD) or as a DBE certified under the FLUCP program, will be eligible to participate on Owner funded contracts as a W/MBE firm pursuant to the Owner's W/MBE and DBE policies and programs.

Bidders are encouraged to refer to the Owner's W/MBE Program and Policy which is posted on the Owner's website: www.TampaAirport.com. Links to the various websites that have directories of certified W/MBE firms are also available on the Owner's website.

- B. W/MBE Obligation: Each contract the Owner executes with the Bidder and each subcontract the Bidder executes with a subcontractor, must include the following clause:

"The bidder/proposer, contractor, supplier/vendor and subcontractor will not discriminate on the basis of race, color, national origin, or sex in the performance of this contract or subsequent subcontracts. The bidder/proposer, contractor, supplier/vendor or subcontractor will carry out applicable requirements of 49 CFR Part 26 in the award and administration of USDOT-assisted contracts. Failure of bidder/proposer, contractor, supplier/vendor or subcontractor to carry out these requirements is a material breach of this contract, which may result in the termination of this contract or such other remedy as the Owner deems appropriate."

- C. Certification of Eligible W/MBEs: To ensure the eligibility of W/MBEs proposed to participate on the Contract, all W/MBEs must be certified by the FLUCP, City of Tampa, Hillsborough County or the State of Florida Office OSD. ***W/MBEs must be certified with the appropriate agencies at the time bids are received and Letters of Certification must be included in the sealed bid envelope when submitted to the Owner.***
- D. W/MBE Goals: W/MBE Goals are established for each specific contract with subcontracting opportunities. No Goal for W/MBE participation has been established for this Contract. However, Bidders are strongly encouraged to propose participation by W/MBEs to perform commercially useful functions of the work required in the Bid by submitting a Letter of Intent for each proposed W/MBE as part of their Bid. In accordance with Owner policy, a recipient may count expenditures of materials and supplies obtained from a W/MBE supplier or company at 100% of the cost of the materials or supplies obtained from a W/MBE Goal.
- E. Bidder Efforts to Meet W/MBE Subcontract Goals:
1. The Bidder will satisfy the Owner that it has made "Good Faith Efforts" to utilize W/MBEs in meeting the established Goal. "Good Faith Efforts" are those efforts that could reasonably be expected to result in W/MBE Goal attainment by a Bidder who aggressively and actively seeks to obtain W/MBE participation.

Efforts that are merely “Pro Forma” are not “Good Faith Efforts” to meet W/MBE Goals. In determining whether or not the apparent successful Bidder has made such “Good Faith Efforts” to meet the Goal, some of the factors the Owner will consider are the following:

- a. Whether the Bidder advertised in newspapers of general circulation, websites, trade association, and minority-focus media concerning the subcontracting opportunities prior to bid opening;
- b. Whether the Bidder provided written notice by certified mail, facsimile or electronic mail prior to the bid submission date to a reasonable number of W/MBEs that their interest in the Contract was being solicited and giving W/MBE sufficient time to prepare a response to the request;
- c. Whether the Bidder followed up initial solicitations of interest by contacting W/MBEs to determine with certainty whether the W/MBEs were interested;
- d. Whether the Bidder selected portions of the Work to be performed by W/MBEs in order to increase the likelihood of meeting the W/MBE Goals including, where appropriate, breaking down contracts into economically feasible units to facilitate W/MBE participation;
- e. Whether the Bidder provided interested W/MBEs with adequate information about the Drawings, Specifications or requirements of the Contract;
- f. Whether the Bidder negotiated in good faith with interested W/MBEs, not rejecting W/MBEs as unqualified without sound reasons based on a thorough investigation of their capabilities;
- g. Whether the Bidder made efforts to assist interested W/MBEs in obtaining bonding, lines of credit, or insurance required by the Owner or Contractor;
- h. Whether the Bidder effectively used the services of available minority community organizations, minority trade or business groups, local, state and federal minority business assistance offices, and other organizations that provide assistance in the recruitment and placement of W/MBEs;
- i. Whether the Scope of Work submitted by the Bidder to any W/MBE contractor, W/MBE subcontractor, W/MBE sub-subcontractor, W/MBE supplier, W/MBE sub-supplier or W/MBE sub-sub-supplier, and so on, either directly or in-directly, was intended to achieve, in whole or in part, the specified W/MBE participation;
- j. Whether the replies or quotes from W/MBEs in response to Scopes of Work provided to them by contractors, either directly or indirectly, were fair and responsive;

- k. Whether the Bidder fairly represented W/MBE quotations in the formulation of the Bidder's bid as shown on the Contractor's bid tabulation or other work documents supporting the Bidder's bid; and
 - l. Whether all other bidders met the W/MBE Goal but the apparent low bidder or most qualified bidder did not.
2. Bidders who do not meet W/MBE contract Goal may satisfy the Good Faith Efforts requirement by documenting their efforts to do so. If the Owner subsequently determines that the Bidder did not satisfy the Good Faith Efforts, the Bidder is entitled, at their option, to the administrative reconsideration process as outlined in the Owner's W/MBE policy.
 3. Any Bidder who meets the W/MBE Goal will be deemed to have made the necessary "Good Faith Efforts" without the need for further proof. Failure to meet the Goal or satisfy the Good Faith Efforts requirements, may cause the Bid to be determined to be non-responsive.
 4. The Owner reserves the right to require such additional and supplemental information solely for the purpose of clarifying the W/MBE information submitted by the Bidder. The determination of whether Bidder's efforts were made in "good faith" will be made by Owner.

END OF SECTION

SECTION 00300 - BID FORM

TO:

HILLSBOROUGH COUNTY AVIATION AUTHORITY
OWNER
Tampa International Airport
Post Office Box 22287
Tampa, Florida 33622

FROM:

BIDDER NAME

Smith Industries, Inc. dba Smith Fence Company

STREET ADDRESS

4699 110th Ave N

CITY, STATE, ZIP

Clearwater FL 33762

DATE

6/12/17

PHONE

727-573-5440

E-MAIL

dwarrington@smithfence.com

(Person to receive recommendation of award notification)

1.01 The undersigned Bidder hereby certifies the following: (1) it has accurately identified all persons required by the applicable signature block; (2) the Bid Prices are fair, in all respects, and made in good faith, without collusion or fraud; (3) no officer, employee or agent of the Owner and no spouse or child of an officer, employee, or agent of the Owner, has, or will have during the performance of the Contract, any material interest in the business of the Bidder, and (4) Bidder has no knowledge of any potential conflict of interest.

The Bidder further represents that it has carefully examined the site of the Work, the Contract Documents, the Addenda furnished prior to the opening of the Bids and existing Owner records for the Work contemplated during the Bid submittal period. By submitting a Bid, the Bidder represents to the Owner that the Bid and the Contract are inclusive of sufficient compensation for performing adequate investigations of existing site conditions, the Contract Documents, and existing records to sufficiently support the design developed by the Bidder. The Bidder further acknowledges that any information provided by the Owner was to assist the Bidder in completing adequate investigations. In addition, the Bidder represents that it has investigated and is fully informed of the conditions to be encountered, of the character, quality and quantities of Work to be performed and materials to be furnished and has included in the Bid and Contract all items necessary for the proper execution and completion of the Work in accordance with the requisite time frame, applicable laws, statutes, building codes, regulations, or as otherwise required by the Contract Documents.

The undersigned, as Bidder, does hereby declare that, having familiarized itself with the local conditions affecting the cost of the Work, Owner's policies, procedures, rules, regulations and manuals affecting the cost of the Work, Contract Documents including the Project Manual (consisting of Bidding and Contract Requirements, and the Specifications), Drawings, and other related Contract Documents prepared by the Owner and titled: Perimeter Fence Rehabilitation, Peter O. Knight & Plant City Airports.

Airport Name: Peter O. Knight & Plant City Airports
Authority Project No.: 6440 17
Project Title: Perimeter Fence Rehabilitation
Dated: May 8, 2017

together with all Addenda to such Contract Documents as listed herein (Paragraph 1.08), it proposes to furnish all materials and labor specified and perform all Work required in strict accordance with the provisions of Contract Documents noted above for the consideration of the prices quoted in Section 00340 - BID SCHEDULE, titled the same as written above, attached hereto and incorporated by reference.

The undersigned understands that the estimated quantities shown in Section 00340 - BID SCHEDULE are approximate only and are intended principally to serve as a guide in evaluating Bids and are subject to either increase or decrease.

- 1.02 The undersigned affirms that in making such Bid, neither Bidder nor any company that Bidder may represent, nor anyone on behalf of Bidder or Bidder's company, directly or indirectly, has entered into any combination, collusion, undertaking or agreement with any other Bidder or Bidders to control the prices of said Work, or any compact to prevent any other Bidder or Bidders from bidding on said Contract or Work, and further affirms that such Bid is made without regard or reference to any other Bidder or Bid and without any agreement or understanding or combination, either directly or indirectly, with any other person or persons with reference to such bidding in any way or manner whatsoever. The undersigned acknowledges that the Owner is relying on the statements made herein.
- 1.03 Each Bidder agrees that all documents relied upon in making or supporting their Bid will be retained in escrow prior to the date the Contract is awarded and will be preserved and maintained during the course of the Work until Final Payment is made. The Owner will have the right to inspect any and all such Bid Documents and to verify that such Bid Documents are properly escrowed, in a manner satisfactory to the Owner, prior to the time of the award of the Contract, or at any time thereafter during the course of the Work.
- 1.04 The undersigned, when notified of the acceptance of this Bid, does hereby agree to enter into a Contract and return such signed (executed) Contract to the Owner along with the fully executed Performance Bond and Payment Bond with good and sufficient Surety and furnish the required Certificates of Insurance and Insurance Policy endorsements, within seven days after the date of award of the Contract.

A preliminary Construction Schedule (based on major items) as required by Section 01315 - SCHEDULES, PHASING will be provided to the Owner by the undersigned within 15 days from the date of the award of the Contract, and will be in accordance with the provisions of the Contract Documents.

The undersigned further agrees that if awarded the Contract, Bidder will commence the Work within ten days after the date of Notice to Proceed and that Bidder will achieve Substantial Completion within 90 days after Notice to Proceed.

The Owner may issue a Notice to Proceed seven days after the date of award of the Contract. However, the Contractor will not use or occupy Owner's premises in connection with the Contract until all documentation required by the Contract Documents has been submitted, accepted and executed by the Owner. Refer to Section 00500 - AWARD OF CONTRACT AND EXECUTION OF CONTRACT BONDS and Section 00650 – INSURANCE REQUIREMENTS.

Should the undersigned fail to achieve Substantial Completion within the time(s) specified in the Contract and the Contract Documents, the Owner may retain the sum specified in the Contract for each day that the Work remains incomplete beyond the time limit(s), which sum will represent not a penalty but liquidation of a reasonable portion of the damages that will be incurred by the Owner by failure of the undersigned to complete the Work within the days stipulated. The undersigned agrees that the assessment of actual damages at the time the Contract is entered into is uncertain. By bidding on the project, the undersigned signifies that it agrees that the sum specified in the Contract for the Liquidated Damages is reasonable. The undersigned agrees that the Liquidated Damages in the Contract are solely for delay and loss of use.

- 1.05 In submitting this Bid, it is understood that the right is reserved by the Owner to waive formalities, technicalities and irregularities and to reject all Bids. It is agreed that this Bid may not be withdrawn for a period of 85 calendar days (or 115 calendar days if federal funds are applicable) after the opening thereof.
- 1.06 The Bidder attaches hereto a Cashier's Check or Bid Bond payable to the Hillsborough County Aviation Authority, as required under Section 00020 – INVITATION TO BID, and the Bidder agrees that in case Bidder fails to fulfill obligations under the Bid, the Owner, may, at its option, determine that the Bidder has abandoned Bidder's rights and interest in such Bid and that the Cashier's Check or Bid Bond accompanying their Bid has been forfeited to the Owner as liquidated damages. Otherwise, the Cashier's Check or Bid Bond will be returned to the Bidder upon the execution and return of the Contract and the acceptance of the Bonds and Insurance, or upon rejection of the Bid. The Bidder agrees that the Liquidated Damages are not a penalty and 5% of the total bid amount is reasonable.
- 1.07 The undersigned affirms that Bidder has completed, signed and included in its Bid submission all documents as listed in Section 00100 – INSTRUCTIONS TO BIDDERS, Item 1.09, R.

When a determination has been made to award a Contract to a specific Bidder, such Bidder will, prior to award, furnish such other pertinent information and assurances regarding Bidder's proposed subcontractors, as the Owner, the FAA, the Secretary of Labor, FDOT, and/or the Office of Federal Contract Compliance (OFCC) may require. The Bidder will furnish similar statements executed by each of Bidder's first-tier and second-tier subcontractors whose Contracts equal \$10,000 or more and will obtain similar compliance by such subcontractors before awarding such subcontracts. No subcontract will be awarded to any non-complying Subcontractor.

It is understood and agreed that all workmanship and materials under all items of work are guaranteed for one year from the date of substantial completion, unless otherwise specified within the Contract Documents.

The undersigned affirms that Bidder has completed all of the blank spaces in the "Bid Schedule" with an amount in words and numbers and agrees that where a discrepancy occurs between the prices quoted in words and/or numbers, the figure quoted in words will take precedence and govern when determining costs or award of Contract.

The undersigned agrees that the Contract Sum will be decreased or increased where planned quantities shown on the Drawings are decreased or increased, and that such increases or decreases will be determined by use of the applicable Unit Price shown on the Unit Price "Bid Schedule."

1.08 The undersigned acknowledges receipt of the following Addenda:

ADDENDUM NUMBER	DATED
<u>1</u>	<u>May 16, 2017</u>
<u>2</u>	<u>June 6, 2017</u>
_____	_____
_____	_____

continue if required . . .

1.09 The legal status of the undersigned is: (The Bidder will complete A. and the appropriate portion of B. or C. and strike out the other one.)

A. Federal Employer Identification (FEI) number: 59-1743161

B. Corporation:

1. A corporation, duly organized and doing business under the laws of the State of Florida, for whom, bearing official title of President, whose signature is affixed to this bid, is duly authorized to execute contracts.

Date of Incorporation: 6.13.1977

Name and address of Florida registered agent for service of process:

Raymond P. Smith III
4699 110th Ave N
Clearwater FL 33762

2. If Foreign Corporation (non-Florida):
Date of Certificate of Authority to transact business in Florida: _____

Name and address of Florida registered agent for service of process:

C. Partnership:

A partnership, all of the members of which, with addresses are: (Designate general partners as such).

_____	_____	_____
_____	_____	_____
_____	_____	_____

continue if required . . .

If all partners are non-residents of Florida: Designate name and address of Florida registered agent required for service of process.

Name and address of Florida registered agent for service of process:

D. Other Entity

A _____, duly organized and duly doing business under the laws of the State of _____, for whom, bearing the title of _____, whose signature is affixed to this bid, is duly authorized to execute contracts.

Name and address of Florida registered agent for service of process:

ALL BIDDERS MUST SIGN AND EXECUTE THE FOLLOWING:

Dated and signed at Clearwater, Florida

on this 12th day of June, 2017.

NAME OF BIDDER Smith Industries, Inc. dba Smith Fence Company

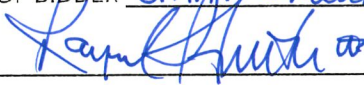
By: 
(Signature)

TITLE President

BUSINESS ADDRESS 4699 110th Ave N
Clearwater FL 33762

WITNESSES:

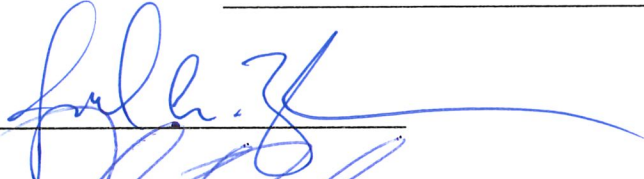
By: 
(Signature)

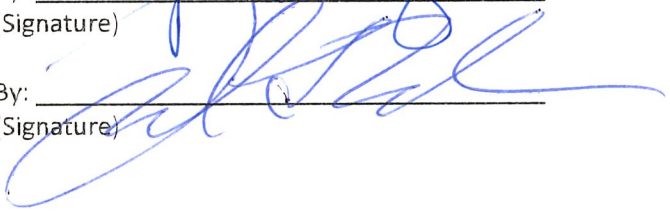
By: 
(Signature)

END OF SECTION

Perimeter Fence Rehabilitation
HCAA Project No. 6440 17
Plant City Airport and Peter O. Knight Airport
Hillsborough County Aviation Authority

Bid Item Number	Item Description and Bid Price Per Unit (In Words)	Bid Price Per Unit (In Numbers)	Est Qty	Unit	Total Amount Per Item Unit Price Times Est Qty
P-100-1	Mobilization (Including Safety and Security)	Five thousand nine hundred and nine Dollars zero Cents \$ 5,909. ⁰⁰	1	LS	\$ 5,909. ⁰⁰
F-162-1	Chain-Link Fence Removal	Two Dollars zero Cents \$ 2. ⁰⁰	10,800	LF	\$ 21,600. ⁰⁰
F-162-2	6' Chain-Link Fence, Black Vinyl Coated with/without 3 Strand Barbed Wire	Seventeen Dollars forty five Cents \$ 17.45	8,255	LF	\$ 144,049.75
F-162-3	6' Chain-Link Fence, Galvanized with 3 Strand Barbed Wire	Thirteen Dollars eighty Cents \$ 13. ⁸⁰	2,425	LF	\$ 33,465. ⁰⁰
F-162-4	Swing Gate (Plant City Airport), Size Varies	One thousand five hundred eighty two Dollars zero Cents \$ 1,582. ⁰⁰	1	LS	\$ 1,582. ⁰⁰
F-162-5	Swing Gate (Peter O. Knight Airport), Size Varies	Thirteen thousand six hundred seventeen Dollars zero Cents \$ 13,617. ⁰⁰	1	LS	\$ 13,617. ⁰⁰

Bid Item Number	Item Description and Bid Price Per Unit (In Words)	Bid Price Per Unit (In Numbers)	Est Qty	Unit	Total Amount Per Item Unit Price Times Est Qty
F-162-6	Fence Bottom Regrading	Two thousand two hundred fifty Dollars Zero Cents \$ 2,250. ⁰⁰	1	LS	\$ 2,250. ⁰⁰
F-162-7	Fence Signage	Twelve thousand nine hundred twenty two Dollars Zero Cents \$ 12,922. ⁰⁰	1	LS	\$ 12,922. ⁰⁰
F-162-8	Swing Gate Hinge Replacement (Double Leaf Gate)	Three hundred six Dollars Zero Cents \$ 306. ⁰⁰	3	EA	\$ 918. ⁰⁰
T-101-1	Clearing, 10' Wide Along Fence Alignment	Twenty six Dollars Seventy Cents \$ 26.70	3,250	LF	\$ 86,775. ⁰⁰
T-101-2	Trimming, Above Existing Fence Alignment	Seven Dollars ten Cents \$ 7. ¹⁰	1,425	LF	\$ 10,117.50
Sub-total for all Bid Items not including Owner's Allowance					\$ 333,205.25
Owner's Allowance					
	Twenty Thousand Dollars Zero Cents \$ 20,000.00	1	Allow	\$ 20,000.00	

Bid Item Number	Item Description and Bid Price Per Unit (In Words)	Bid Price Per Unit (In Numbers)	Est Qty	Unit	Total Amount Per Item Unit Price Times Est Qty
-----------------	---	------------------------------------	---------	------	---

Total Bid Amount including Owner's Allowance

Three hundred fifty-three thousand two hundred five Dollars twenty five Cents \$ 353,205.25
Total Bid Amount in Words In Numbers

NOTE: Basis of payment will be in accordance with the technical specifications applicable to each Bid Item Number.

Name of Bidder: Smith Industries, Inc.
dba Smith Fence Company
(Typed or Printed)

Signature of Bidder: [Signature]
(Same as Bid Form)

Title: President

Date: 6.12.17

SECTION 00350 - BID AFFIDAVIT

The following affidavit will be executed in order that your Bid may be considered:

STATE OF Florida

COUNTY OF Pinellas

Raymond P. Smith of lawful age, being first duly sworn, deposes and says: That it executed the accompanying Bid on behalf of the Contractor named herein, and that it had lawful authority so to do, and said Contractor has not directly or indirectly entered into any agreement, express or implied, with any contractor or contractors, having for its object the controlling of the price or amount of such Bid or any Bids, the limiting of the Bid of contractors, the parceling or farming out to any contractor or contractors or to other persons of any part of the Contract or any of the subject matter of the Bids, or of the profits thereof, and that it has not and will not divulge the sealed Bid to any person whomsoever, except those having a partnership or other financial interest with them in said Bid or Bids, until after the sealed Bid or Bids are opened.

Signed By: [Signature] Raymond P. Smith President

Subscribed and sworn to before me this 12th day of June, 2017.



My Commission Expires: 4.23.20

By: [Signature]
Notary Public (Signature)

[Affix Corporate Resolution if not signed by the President or Vice President of the Company]

END OF SECTION

(NOT TO BE FILLED OUT IF A CASHIER'S CHECK IS SUBMITTED)

KNOW ALL MEN BY THESE PRESENTS: That the undersigned Smith Industries, Inc. dba Smith Fence Company
4699 110th Avenue N., Clearwater, FL 33762

as Principal, and Berkley Insurance Company

as Surety, are held and firmly bound unto the **Hillsborough County Aviation Authority** in the sum of 5% of the bid amount shown on 00340 – BID SCHEDULE for the payment of which, well and truly to be made, we hereby jointly and severally bind ourselves, our heirs, executors, administrators, successors and assigns.

THE CONDITION OF THIS OBLIGATION is such that if Principal:

1. Does not withdraw the attached Bid Amount shown on 00340 – BID SCHEDULE for the Authority Project No. **6440 17 entitled Perimeter Fence Rehabilitation at Peter O. Knight & Plant City Airports** for a period of 85 calendar days (or 115 calendar days if federal funds are applicable) after the date on which the Bids are opened; and

2. Enters into a written Contract and furnishes the required Insurance, Certificates of Insurance and Payment and Performance Bonds with surety or sureties acceptable to the **Hillsborough County Aviation Authority** within seven days after the date of award of the Contract, then this obligation will be void; Otherwise the same will be in full force and the full amount of this Bid Bond will be paid to the **Hillsborough County Aviation Authority** as stipulated herein.

Signed this 13th day of June, 2017.

CONTRACTOR MUST INDICATE WHETHER CORPORATION, PARTNERSHIP, COMPANY, (OR INDIVIDUAL). THE PERSON SIGNING FOR THE CONTRACTOR WILL SIGN HIS/HER OWN NAME AND SIGN CORPORATE TITLE. WHEN THE PERSON SIGNING FOR A CORPORATION IS OTHER THAN THE PRESIDENT OR VICE PRESIDENT, HE/SHE MUST FURNISH A CORPORATE RESOLUTION SHOWING HIS/HER AUTHORITY TO BIND THE CORPORATION

(Affix Contractor's Corporate Seal)
Smith Industries, Inc. dba Smith Fence Company

By: 

Name of Contractor

(Signature)

Type Name and Title Below:

Address: 4699 110th Avenue N.
Clearwater, FL 33762

Raymond P Smith III, President

727-573-5440

727-573-2075

Telephone Number

Fax Number

(Affix Surety's Corporate Seal)

Berkley Insurance Company

Name of Surety

By: 

Attorney in Fact for Surety (Signature)

By: 

Florida Licensed Agent (Signature)

Type name of Attorney in Fact: Anthony T. Papa, Jr.

Type name of Fla. Licensed Agent: Anthony T. Papa, Jr.

Attorney in Fact Address: 7264 Kyle Court
Sarasota, FL 34240

Agent Address: 7264 Kyle Court
Sarasota, FL 34240

941-999-1900

941-306-2002

Telephone Number

Fax Number

941-999-1900

941-306-2002

Telephone Number

Fax Number

TPF & PCM / PERIMETER FENCE REHABILITATION

SECTION 00400 2-SURETY BOND AFFIDAVIT

STATE OF FLORIDA
COUNTY OF SARASOTA

BEFORE ME, THE UNDERSIGNED AUTHORITY, PERSONALLY APPEARED Anthony T. Papa, Jr., WHO, BEING DULY SWORN, DEPOSES AND SAYS THAT THEY ARE A DULY AUTHORIZED FLORIDA LICENSED INSURANCE AGENT, PROPERLY LICENSED UNDER THE LAWS OF THE STATE OF FL, TO REPRESENT Berkley Insurance Company OF 475 Steamboat Road, Greenwich, CT 06830, A COMPANY AUTHORIZED TO MAKE CORPORATE SURETY BONDS UNDER THE LAWS OF THE STATE OF FL (THE "SURETY").

SAID Anthony T. Papa, Jr. FURTHER CERTIFIES THAT AS AGENT FOR THE SAID Smith Industries, Inc. dba Smith Fence Company THEY HAVE SIGNED THE ATTACHED BOND AS A LICENSED AGENT, IN THE SUM OF 5% OF THE BID AMOUNT SHOWN ON 00340-BID SCHEDULE, ON BEHALF OF Berkley Insurance Company TO THE **HILLSBOROUGH COUNTY AVIATION AUTHORITY COVERING Project No. 6440 17 entitled Perimeter Fence Rehabilitation at Peter O. Knight & Plant City Airports.**

SIGNED:
By: [Signature]
Florida Licensed Insurance Agent (Signature)
Anthony T. Papa, Jr.
7264 Kyle Court, Sarasota, FL 34240
Address Of Agent
941-999-1900
Phone Number
941-306-2002
Fax Number
475 Steamboat Road, Greenwich, CT 06830
Address Of Bond Company
203-542-3800
Phone Number
203-542-3839
Fax Number

SURETY:
By: [Signature]
Attorney-In-Fact (Signature)
Anthony T. Papa, Jr.
Acknowledgment For
Attorney-In-Fact

Sworn To And Subscribed
Before Me This 13th Day
Of June, 2018.7

By: [Signature]
(Signature of Notary Public)

NOTARY PUBLIC
STATE OF FLORIDA
MY COMMISSION EXPIRES: 1/6/2021



END OF SECTION

POWER OF ATTORNEY
BERKLEY INSURANCE COMPANY
WILMINGTON, DELAWARE

NOTICE: The warning found elsewhere in this Power of Attorney affects the validity thereof. Please review carefully.

KNOW ALL MEN BY THESE PRESENTS, that BERKLEY INSURANCE COMPANY (the "Company"), a corporation duly organized and existing under the laws of the State of Delaware, having its principal office in Greenwich, CT, has made, constituted and appointed, and does by these presents make, constitute and appoint: *Carol A. McManus; Christine A. Papa; Teresa L. Steadman; Anthony T. Papa, Jr.; or Edward James Wood III of Guy Hurley of Florida, LLC of Sarasota, FL* its true and lawful Attorney-in-Fact, to sign its name as surety only as delineated below and to execute, seal, acknowledge and deliver any and all bonds and undertakings, with the exception of Financial Guaranty Insurance, providing that no single obligation shall exceed **Fifty Million and 00/100 U.S. Dollars (U.S.\$50,000,000.00)**, to the same extent as if such bonds had been duly executed and acknowledged by the regularly elected officers of the Company at its principal office in their own proper persons.

This Power of Attorney shall be construed and enforced in accordance with, and governed by, the laws of the State of Delaware, without giving effect to the principles of conflicts of laws thereof. This Power of Attorney is granted pursuant to the following resolutions which were duly and validly adopted at a meeting of the Board of Directors of the Company held on January 25, 2010:

RESOLVED, that, with respect to the Surety business written by Berkley Surety Group, the Chairman of the Board, Chief Executive Officer, President or any Vice President of the Company, in conjunction with the Secretary or any Assistant Secretary are hereby authorized to execute powers of attorney authorizing and qualifying the attorney-in-fact named therein to execute bonds, undertakings, recognizances, or other suretyship obligations on behalf of the Company, and to affix the corporate seal of the Company to powers of attorney executed pursuant hereto; and said officers may remove any such attorney-in-fact and revoke any power of attorney previously granted; and further

RESOLVED, that such power of attorney limits the acts of those named therein to the bonds, undertakings, recognizances, or other suretyship obligations specifically named therein, and they have no authority to bind the Company except in the manner and to the extent therein stated; and further

RESOLVED, that such power of attorney revokes all previous powers issued on behalf of the attorney-in-fact named; and further

RESOLVED, that the signature of any authorized officer and the seal of the Company may be affixed by facsimile to any power of attorney or certification thereof authorizing the execution and delivery of any bond, undertaking, recognizance, or other suretyship obligation of the Company; and such signature and seal when so used shall have the same force and effect as though manually affixed. The Company may continue to use for the purposes herein stated the facsimile signature of any person or persons who shall have been such officer or officers of the Company, notwithstanding the fact that they may have ceased to be such at the time when such instruments shall be issued.

IN WITNESS WHEREOF, the Company has caused these presents to be signed and attested by its appropriate officers and its corporate seal hereunto affixed this 9th day of September, 2014.

Attest:

(Seal)

By Ira S. Lederman
Ira S. Lederman
Senior Vice President & Secretary

Berkley Insurance Company

By Jeffrey M. Hafter
Jeffrey M. Hafter
Senior Vice President

WARNING: THIS POWER INVALID IF NOT PRINTED ON BLUE "BERKLEY" SECURITY PAPER.

STATE OF CONNECTICUT)

) ss:

COUNTY OF FAIRFIELD)

Sworn to before me, a Notary Public in the State of Connecticut, this 9th day of September, 2014, by Ira S. Lederman and Jeffrey M. Hafter who are sworn to me to be the Senior Vice President and Secretary, and the Senior Vice President, respectively, of Berkley Insurance Company.

MARIA C. RUNDBAKEN
NOTARY PUBLIC
MY COMMISSION EXPIRES
APRIL 30, 2019

Maria C. Rundbaken
Notary Public, State of Connecticut

CERTIFICATE

I, the undersigned, Assistant Secretary of BERKLEY INSURANCE COMPANY, DO HEREBY CERTIFY that the foregoing is a true, correct and complete copy of the original Power of Attorney; that said Power of Attorney has not been revoked or rescinded and that the authority of the Attorney-in-Fact set forth therein, who executed the bond or undertaking to which this Power of Attorney is attached, is in full force and effect as of this date.

Given under my hand and seal of the Company, this 13th day of June, 2017.

(Seal)

Andrew M. Tuma
Andrew M. Tuma

WARNING - Any unauthorized reproduction or alteration of this document is prohibited. This power of attorney is void unless seals are readable and the certification seal at the bottom is embossed. The background imprint, warning and verification instructions (on reverse) must be in blue ink.

SECTION 00417 - WOMAN AND MINORITY OWNED BUSINESS ENTERPRISE (W/MBE) ASSURANCE AND PARTICIPATION

PERIMETER FENCE REHABILITATION
AUTHORITY PROJECT NO. 6440 17
PETER O. KNIGHT AND PLANT CITY AIRPORTS

Select one of the following responses below.

No. Bidder is NOT proposing W/MBE Goal.

No specific Goal for W/MBE participation has been established for this Solicitation; however, the Bidder will make a good faith effort, in accordance with Authority's W/MBE Policy and Program, throughout the term of the awarded Contract, to subcontract with W/MBE firms certified as a woman-owned or minority-owned business by the City of Tampa, Hillsborough County, State of Florida Department of Management Services, Office of Supplier Diversity (OSD), or as a Disadvantaged Business Enterprise (DBE) under the Florida Unified Certification Program (FLUCP), in the performance of the awarded Contract.

OR

Yes. Bidder is proposing W/MBE participation Goal.

The Bidder assures that it will subcontract with W/MBE firms in an amount equal to at least ___% of the total dollar amount of the awarded Contract. The Bidder is required to submit a Letter of Intent for each W/MBE that is proposed to participate in the awarded Contract at the time the Bid is submitted to the Owner. The actual W/MBE contractual commitment will be the total amount of participation shown on the validated Letter(s) of Intent submitted by the Bidder. It is understood that the amounts shown on the Letter(s) of Intent are estimates and that actual amounts paid to W/MBE subcontractors may vary depending on the final adjustments of the estimated quantities; however, the W/MBE contractual commitment can only be modified by an amendment or change order.

By: Name of Bidder: Smith Industries, Inc. dba Smith Fence Company Date: 6-12-17

Bidder Representative's Name: Raymond P. Smith III Title: President
[Signature]

(Bidder Representative's Signature)

SECTION 00417 - WOMAN AND MINORITY OWNED BUSINESS ENTERPRISE (W/MBE) ASSURANCE AND PARTICIPATION

PERIMETER FENCE REHABILITATION
AUTHORITY PROJECT NO. 6440 17
PETER O. KNIGHT AND PLANT CITY AIRPORTS

Letter of Intent Instructions Checklist

Follow this checklist when completing the Letter of Intent.

N/A

0% W/MBE

- A separate Letter of Intent has been completed for each proposed W/MBE firm.
- The Bidder's name, address, telephone number, FAX number and e-mail address has been entered.
- The proposed W/MBE firm's name, address, telephone number, FAX number and e-mail address has been entered.
- The description of the work to be performed by the W/MBE firm has been entered.
- The amount of the proposed W/MBE firm's subcontract has been entered.
- The Bidder has completed and signed the Commitment section.
- The W/MBE firm has completed and signed the Affirmation section.
- A copy of the W/MBE firm's certification letter by the City of Tampa, Hillsborough County, State of Florida Department of Management Services, Office of Supplier Diversity (OSD) or DBE certification letter under the Florida Unified Certification Program (FLUCP) is attached to the Letter of Intent.

SECTION 00417 - WOMAN AND MINORITY OWNED BUSINESS ENTERPRISE (W/MBE) ASSURANCE AND PARTICIPATION

PERIMETER FENCE REHABILITATION
AUTHORITY PROJECT NO. 6440 17
PETER O. KNIGHT AND PLANT CITY AIRPORTS

Letter of Intent

Name of Bidder's firm: N/A 0% W/MBE
Address: _____
City: _____ State: _____ Zip Code: _____
Phone: _____ Fax number: _____
E-mail: _____

Name of W/MBE firm: _____
Address: _____
City: _____ State: _____ Zip Code: _____
Phone: _____ Fax number: _____
E-mail: _____

Description of work to be performed by W/MBE firm: _____

Amount of the W/MBE firm's subcontract \$ _____

Commitment

The Bidder is committed to utilizing the above-named W/MBE firm for the work described above.

By: Name of Bidder: _____ Date: _____

Bidder Representative's Name: _____ Title: _____

(Bidder Representative's Signature)

Affirmation

By: Name of W/MBE Firm: _____ Date: _____

W/MBE Representative's Name: _____ Title: _____

(W/MBE Representative's Signature)

SECTION 00417 - WOMAN AND MINORITY OWNED BUSINESS ENTERPRISE (W/MBE) ASSURANCE AND PARTICIPATION

PERIMETER FENCE REHABILITATION
AUTHORITY PROJECT NO. 6440 17
PETER O. KNIGHT AND PLANT CITY AIRPORTS

Letter of Intent

If the Bidder does not receive award of the Contract, any and all representations in this Letter of Intent will be null and void.

NOTE: The cost of materials and/or supplies obtained and/or equipment leased by the W/MBE to perform the subcontract work (except supplies and equipment the W/MBE subcontractor purchases or leases from the prime contractor or its affiliate) may be included in the subcontract amount. In addition, the Owner will count 100% of the expenditures on materials and/or supplies obtained from a W/MBE manufacturer or regular dealer. With respect to materials or supplies purchased from a W/MBE which is neither a manufacturer nor a regular dealer, the Owner will count only the amount of fees or commissions charged for assistance with the procurement of the material or supplies, or fees or transportation charges for the delivery of materials or supplies required on a job site.

END OF SECTION

SECTION 00417 - WOMAN AND MINORITY OWNED BUSINESS ENTERPRISE (W/MBE) ASSURANCE AND PARTICIPATION

PERIMETER FENCE REHABILITATION
AUTHORITY PROJECT NO. 6440 17
PETER O. KNIGHT AND PLANT CITY AIRPORTS

Letter of Intent Instructions Checklist

Follow this checklist when completing the Letter of Intent.

N/A

0% W/MBE

- A separate Letter of Intent has been completed for each proposed W/MBE firm.
- The Bidder's name, address, telephone number, FAX number and e-mail address has been entered.
- The proposed W/MBE firm's name, address, telephone number, FAX number and e-mail address has been entered.
- The description of the work to be performed by the W/MBE firm has been entered.
- The amount of the proposed W/MBE firm's subcontract has been entered.
- The Bidder has completed and signed the Commitment section.
- The W/MBE firm has completed and signed the Affirmation section.
- A copy of the W/MBE firm's certification letter by the City of Tampa, Hillsborough County, State of Florida Department of Management Services, Office of Supplier Diversity (OSD) or DBE certification letter under the Florida Unified Certification Program (FLUCP) is attached to the Letter of Intent.

SECTION 00417 - WOMAN AND MINORITY OWNED BUSINESS ENTERPRISE (W/MBE) ASSURANCE AND PARTICIPATION

PERIMETER FENCE REHABILITATION
AUTHORITY PROJECT NO. 6440 17
PETER O. KNIGHT AND PLANT CITY AIRPORTS

Letter of Intent

Name of Bidder's firm: N/A 0% W/MBE
Address: _____
City: _____ State: _____ Zip Code: _____
Phone: _____ Fax number: _____
E-mail: _____

Name of W/MBE firm: _____
Address: _____
City: _____ State: _____ Zip Code: _____
Phone: _____ Fax number: _____
E-mail: _____

Description of work to be performed by W/MBE firm: _____

Amount of the W/MBE firm's subcontract \$ _____

Commitment

The Bidder is committed to utilizing the above-named W/MBE firm for the work described above.

By: Name of Bidder: _____ Date: _____

Bidder Representative's Name: _____ Title: _____

(Bidder Representative's Signature)

Affirmation

By: Name of W/MBE Firm: _____ Date: _____

W/MBE Representative's Name: _____ Title: _____

(W/MBE Representative's Signature)

SECTION 00417 - WOMAN AND MINORITY OWNED BUSINESS ENTERPRISE (W/MBE) ASSURANCE AND PARTICIPATION

PERIMETER FENCE REHABILITATION
AUTHORITY PROJECT NO. 6440 17
PETER O. KNIGHT AND PLANT CITY AIRPORTS

Letter of Intent

If the Bidder does not receive award of the Contract, any and all representations in this Letter of Intent will be null and void.

NOTE: The cost of materials and/or supplies obtained and/or equipment leased by the W/MBE to perform the subcontract work (except supplies and equipment the W/MBE subcontractor purchases or leases from the prime contractor or its affiliate) may be included in the subcontract amount. In addition, the Owner will count 100% of the expenditures on materials and/or supplies obtained from a W/MBE manufacturer or regular dealer. With respect to materials or supplies purchased from a W/MBE which is neither a manufacturer nor a regular dealer, the Owner will count only the amount of fees or commissions charged for assistance with the procurement of the material or supplies, or fees or transportation charges for the delivery of materials or supplies required on a job site.

END OF SECTION

SECTION 00418 - CERTIFICATE OF NON-SEGREGATED FACILITIES

CERTIFICATION TO BE SUBMITTED BY CONSTRUCTION CONTRACTORS OF APPLICANTS AND THEIR SUBCONTRACTORS (APPLICABLE TO CONSTRUCTION CONTRACTS AND RELATED SUBCONTRACTS EXCEEDING TEN THOUSAND DOLLARS (US \$10,000.00) WHICH ARE NOT EXEMPT FROM THE EQUAL OPPORTUNITY CLAUSE)

The construction Contractor certifies that it does not maintain or provide, for its employees, any segregated facilities at any of its establishments and that construction Contractor does not permit its employees to perform their services at any location, under construction Contractor's control, where segregated facilities are maintained. The construction Contractor certifies that it will not maintain or provide, for its employees, segregated facilities at any of its establishments and that construction Contractor will not permit its employees to perform their services at any location, under construction Contractor's control, where segregated facilities are maintained. The construction Contractor agrees that a breach of this certification is a violation of the equal opportunity clause in this Contract. As used in this certification, the term "segregated facilities" means any waiting room, work areas, restrooms and washrooms, restaurants and other eating areas, time clocks, locker rooms and other storage or dressing areas, parking lots, drinking fountains, recreation or entertainment areas, and transportation and housing facilities provided for employees which are segregated by explicit directives or are in fact segregated on the basis of race, color, religion, or national origin because of habit, local custom, or any other reason. The construction Contractor agrees that (except where it has obtained identical certifications from proposed subcontractors for specific time periods) it will obtain identical certifications from proposed subcontractors prior to the award of subcontracts exceeding ten thousand dollars (US \$10,000.00) which are not exempt from the provisions of the equal opportunity clause and that construction Contractor will retain such certifications in its files.

Smith Industries, Inc. dba Smith Fence Company
(Name of Bidder)

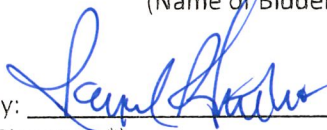
By: 
(Signature*)

Title: President

Date: 6.12.17

* Must be same signature on Bid Form.

END OF SECTION

SECTION 00420 - BIDDER'S GENERAL BUSINESS INFORMATION

(Bidders will fully respond to all items)

Each Bidder will furnish with their Bid the following completed and signed statement pertaining to the Bidder's general business information. In addition, the Owner reserves the right to conduct additional investigations into the Bidder's financial viability, work experience and available assets as the Owner may deem necessary to facilitate administration of the Contract in accordance with the Contract Documents. Each Bidder will fully cooperate with all such investigations.

FIRM: Smith Industries, Inc. dba Smith Fence Company
ADDRESS: 4699 110th Ave N
Clearwater FL 33762
PHONE: 727.573.5440

Contact in your firm for inquiries: David Warrington
Years in business under present name: 40 years
Date of Incorporation: 6.13.77
Place of Incorporation: Clearwater Florida
Contracting specialties: Fence Erection Specialist
Years performing work specialties: 40 years
Geographic areas of business operation: Florida, all of southeast us. & us.
Europe / Canada

List all Projects presently under contract:

Sumter County Public Safety, Hammock/Blue Cypress/Loggerhead Solar Farms, Port of TPA Berth 219, FPL Parrish, Iowa Speedway, Duke Energy Live Oak, USF Enhancements, Pasco School B, USCG, Morningside Rec, Tarpon Spring Fire Station, Manatee Players, Pasco School GGG, PINCO Jail, East Lake Middle, Spectrum Stadium, Miami Dolphins Stadium, NBC Tlhemundo, Baycare Tampa, Enterprise R.A.C, Con Rac @ TIA
(Attach additional sheet(s) if necessary)

Work performed in last two years:

St Pete Grand Prix, Charlotte Tech, Punta Gorda Jail, Montreal Formula 1, Morin Largo, General RV, Eddie Moore Softball, Home Depot Bradenton, Manatee Tax Collect, Port of TPA Berth 214, Fed Ex Ground Orlando, Homestead Speedway, Coca Cola Dinedin, Big Bend Solar, West Palm Running Rail, FL Southwest College, TB Water, Tampa JCC, Pasco Elem W, Surf Song, Duke Citrus Cty, Lowes St Augustine, Dover Speedway, Berkley Prep.

(Attach additional sheet(s) if necessary)

Contract value of work presently under construction: \$ 5,978,600

Average annual contract value of construction work last three years: \$ 19,375,000.

Total bonding capacity: \$ 15 Million

Value of work presently bonded: \$ 2,830,435

Bonding Company: Guy Hurley of Florida LLC
Address: 7264 Kyle Ct. Sarasota FL 34240

Insurance Agent: Stahl & Associates / WORK Comp Partners
Address: 110 Carillon Pkwy / 702 Tillman Place
Phone: St Petersburg FL 33716 / Plant City FL 33566
727.391.9791 / 813.747.7490

What types of work are generally performed by your own forces?

Fabrication & installation of temporary and permanent fencing and gates. Access controls.

(Attach additional sheet(s) if necessary)

What work will be performed by your own forces on this Project?

Removal and replacement of perimeter security fence and gates at Peter O Knight and Plant City Airports.

(Attach additional sheet(s) if necessary)

Total employees employed by firm: 70

Engineers & Design Professionals	<u>-</u>	Estimators	<u>12</u>
CPM Schedulers	<u>2</u>	Tradesmen / welders	<u>3</u>
Project Managers	<u>9</u>	Purchasing Agents	<u>1</u>
Superintendents	<u>3</u>	Other (Describe)	<u>installers - 33</u>
			<u>admin/office/accounting - 7</u>

In-House Engineering or fabrication capability: yes - Fabrication facility for gates

Fabricating floor area (square feet): 3000 sqft.

Value of capital equipment owned by firm: \$ 1,782,986

Bank references and addresses:

Republic Bank - Jim Dusil

6300 4th St N

St Petersburg FL 33702

727.526.5678

Does the firm have experience with projects of a similar nature and scope within the past ten years? If yes, describe:

Project and Location	Design Professional	Contract with (Firm, Address, Person, Phone)	Amount	Date Completed
<u>Security Fence Improvements Lakeland FL</u>	<u>RS & H</u>	<u>City of Lakeland 1140 E. Parker St. Lakeland FL 33801 Linda Alspugh 863.834.6793</u>	<u>437,801</u>	<u>est. completion July 2017</u>
<u>Project 6240.14 Perimeter Fence Rehab Tampa Executive Airport</u>	<u>RS & H</u>	<u>Hillsborough County Aviation Authority Chris Wilson 813.676.4409</u>	<u>224,145</u>	<u>March 2015</u>

(Attach additional sheet(s) if necessary)

See additional aviation projects attached

Has the firm failed to complete a contract within the past ten years? If yes, describe:

N/A - no

(Attach additional sheet(s) if necessary)

Has the firm been debarred, suspended or prohibited from contracting or bidding with a Federal, State or local Government entity during the past ten years? If yes, describe:

N/A - no

(Attach additional sheet(s) if necessary)

Has the firm been involved in a bankruptcy or reorganization within the past ten years? If yes, describe:

N/A - no

(Attach additional sheet(s) if necessary)

Does the firm have any pending claims or suits by others against firm? If yes, describe:

N/A - no

(Attach additional sheet(s) if necessary)

Does the firm have any pending claims or suits against others? If yes, describe:

N/A - no

(Attach additional sheet(s) if necessary)

Has the firm filed written claims or suits against others within the past two years? If yes, describe:

N/A - no

(Attach additional sheet(s) if necessary)

Has the firm been assessed liquidated damages within the past five years? If yes, describe:

N/A - no

(Attach additional sheet(s) if necessary)

Has the firm been refused a bond within the past five years? If yes, describe:

N/A - no

(Attach additional sheet(s) if necessary)

Is the firm in compliance with all EEO requirements? Yes

List three most significant projects presently under construction:

Project and Location	Design Professional	Contract with (Firm, Address, Person, Phone)	Amount	Date Completed
Miami Dolphins Stadium Renovations Miami FL	HOK	Hunt/AECOM 347 Don Shula Dr. Miami Gardens FL Sarosh Siddiqui 305.325.0577	2,645,000	under construction
Julian B. Lane Tampa FL	Civitas	Skanska USA 4030 W. Boy Scout Tampa FL Jake Kriebel 813.477.6060	455,793.	Under Construction

(Attach additional sheet(s) if necessary)

TPF & PCM / PERIMETER FENCE REHABILITATION

Authority No. 6440 17
Pasco High School
GGG
Wesley Chapel FL

BIDDER'S GENERAL BUSINESS INFORMATION
Pasco School District

412,640
Cutler Associates
8918 Brittany Way
Tampa FL
Rick Leatz 813.637.8883

under construction
00420-5

Name of individual with direct managerial responsibility for this entire Project:

David Warrington

List the name, title, experience, and area of responsibility of each project manager and superintendent which Bidder will use on this Project:

Name	Title	Experience in this type of work (years)	Area of Responsibility
<u>David Warrington</u>	<u>Project Manager</u>	<u>30</u>	<u>Project management pay apps / close out</u>
<u>Jack Kramer</u>	<u>Superintendent</u>	<u>25</u>	<u>oversee installation</u>
<u>Tommy Smith</u>	<u>V. President / Asst. PM</u>	<u>35</u>	<u>Project management assistance</u>

(Attach additional sheet(s) if necessary)

ENCLOSE A COPY OF LATEST FINANCIAL STATEMENT.

This form will be signed by an Officer of the firm or an individual so authorized by an Officer of the firm.

Type of firm:

Corporation: _____
 Partnership: _____
 Sole Proprietorship: _____

Name: Smith Industries, Inc. dba Smith Fence Company

Signature: [Handwritten Signature]

Title: President

Date: 6.12.17

END OF SECTION

SECTION 00421 - SCRUTINIZED COMPANY CERTIFICATION

This certification is required pursuant to Florida Statute Section 287.135.

As of October 1, 2016, a company that, at the time of bidding or submitting a bid/response for a new contract/agreement or renewal of an existing contract/agreement, is on the Scrutinized Companies with Activities in Sudan List, the Scrutinized Companies with Activities in the Iran Petroleum Energy Sector List or the Scrutinized Companies that Boycott Israel List, created pursuant to Florida Statute Section 215.473, has been engaged in business operations in Syria, is ineligible for, and may not bid on, submit a bid/response for, or enter into or renew a contract/agreement with an agency or local governmental entity for goods or services of \$1 million or more.

Company: Smith Industries Inc.
dba Smith Fence Company FID or EIN No.: 59-1743161

Address: 4699 110th Ave N City/State/Zip: Clearwater FL 33762

I, Raymond P. Smith III as a representative of Smith Industries, Inc. dba Smith Fence Company certify and affirm that this company is not on the Scrutinized Companies with Activities in Sudan List, the Scrutinized Companies with Activities in the Iran Petroleum Energy Sector List or the Scrutinized Companies that Boycott Israel List, or engaged in business operations in Syria.

Raymond P. Smith III Signature Title President
Raymond P. Smith III Printed Name Date 6.12.17

END OF SECTION

SECTION 00422 - E-VERIFY CERTIFICATION

This certification is required in accordance with the State of Florida, Office of the Governor, Executive Order Number 11-116 (Verification of Employment Status).

The State of Florida, Office of the Governor, Executive Order Number 11-116 (Verification of Employment Status), and any projects with Florida Department of Transportation (FDOT) funding as part of a Joint Participation Agreement between FDOT and the Authority, require, as a condition of all contracts for the provision of goods or services, an express requirement that contractors utilize the U.S. Department of Homeland Security's E-Verify system to verify the employment eligibility of all new employees hired by the contractor during the term of the contract, and an express requirement that contractors include in subcontracts the requirement that subcontractors performing work or providing services pursuant to the contract utilize the E-Verify system to verify the employment eligibility of all new employees hired by the subcontractor during the contract term.

Company: Smith Industries, Inc.
dba Smith Fence Company FID or EIN No.: 59-1743161

Address: 4699 110th Ave N City/State/Zip: Clearwater FL 33762

I, Raymond P. Smith III, as a representative of Smith Industries, Inc. dba Smith Fence Company
certify and affirm that this company will comply with the E-Verification requirements of Executive Order
Number 11-116.

Raymond P. Smith III Signature Title President

Raymond P. Smith III Printed Name Date 6.12.17

[Affix Corporate Resolution if not signed by the President or Vice President of the Company]

END OF SECTION

SECTION 00423 - NON-COLLUSION CERTIFICATE

The essence of competitive bidding is that the Owner shall receive bona fide competitive Bids from all those bidding. In recognition of this principle, the undersigned certifies that this is a bona fide Bid, intended to be competitive, and that Bidder has not fixed or adjusted the amount of the Bid price by, or under, or in accordance with any agreement or arrangement with any other person or entity. The undersigned, who has Authority to make the following representation on behalf of the Bidder, also certifies that Bidder has not done and will not do at any time before the hour and date specified for the submission of the Bid any of the following acts:

- (a) communicate to a person other than the person soliciting for these Bids the amount or approximate amount of the Bid price, except where the disclosure, in confidence, of the approximate amount of the Bid price is necessary to obtain insurance premium and/or bond quotations required for the preparation of the Bid;
- (b) enter into any agreement or arrangement with any other person or entity that such person or entity shall refrain from bidding or as to the amount of any Bid price to be submitted;
- (c) offer, pay, give or agree to pay, offer or give any sum of money or valuable consideration directly or indirectly to any person or entity for doing or having done or having caused to be done in relation to any other Bid or Bid price for the said work, act or thing of the sort described above.

In this certificate, the word "person" includes any persons or any body or association, corporate or unincorporated; and any agreement or arrangement includes any such transaction, formal or informal and whether legally binding or not.

Signed: Raymond P. Smith

Witnessed By: [Signature]

Name: Raymond P. Smith

Date: 6.12.17

For and on behalf of: Smith Industries Inc. dba Smith Fence Company
[Bidder's Name]

Signed: _____

Witnessed by: _____

Name: _____

Date: _____

END OF SECTION

SECTION 00430 - SUBCONTRACTORS LIST

THIS SUBCONTRACTORS LIST IS REQUIRED FOR SUBMISSION WITH BID DOCUMENTS.

This list is attached to and is made an integral part of Bid submitted by: (Bidder to insert full name and address)

Smith Industries, Inc. dba Smith Fence Company
4699 110th Ave N
Clearwater FL 33762

For the construction of:

PERIMETER FENCE REHABILITATION
AUTHORITY NO. 6440 17

PETER O. KNIGHT & PLANT CITY AIRPORTS

The undersigned, hereinafter called "Bidder", lists below the names of the subcontractors who will perform the portions of the Work indicated. If Bidder, instead of a subcontractor, will perform the portions of the Work indicated, Bidder will insert its own name on the appropriate lines. All blank lines will be filled in with the name of the Bidder or a subcontractor. Subcontractor will meet the experience requirements of the appropriate specification section.

SUBCONTRACT

NAME, ADDRESS AND PHONE
NUMBER OF SUBCONTRACTOR

Tree Clearing/ Trimming

Pete & Ron Tree Service
Darrell Goolsby
PO Box 15877 Tampa FL 3368
813.876.4444

SUBCONTRACT

NAME, ADDRESS AND PHONE
NUMBER OF SUBCONTRACTOR

OTHERS

The Bidder declares that it has fully investigated each subcontractor listed, has received and has in its files evidence that each subcontractor maintains a fully equipped organization capable, technically and financially, of performing the pertinent Work, and that Bidder has performed similar installations in a satisfactory manner. The Bidder further declares that it will not change any of these designated subcontractors for Work under this Contract without Owner's written permission.

In witness thereof, the Bidder has hereunto set its signature and affixed its seal this

12th day of June, 2017.

Smith Industries, Inc. dba Smith Fence Company

Name of Bidder

By:

[Handwritten Signature]

(Signature*)

Title:

President

* Must be same signature on Bid Form.

END OF SECTION

SECTION 00440 - BIDDER'S SELECTION OF PAYMENT METHOD

The Authority offers suppliers the option of receiving payments via ePayables or via Automated Clearing House (ACH).

A. Bidder has the option to receive payments utilizing an ePayables solution during the entire term of this Contract either by utilizing ePayables with Authority's Reverse Discount or ePayables under the Large Ticket Vendor Program. Payment will be processed by Accounts Payable using the ePayable system upon Account Payable's receipt of a Pay Application. After the payment is processed, the Pay Application will be reviewed and verified by the Project Manager. Bidder retains the right to request a review of the rejected or corrected Pay Application. Any further adjustment to the Pay Application resulting from the review will be made in the next billing period. Merchant services fees will apply and are determined by Bidder's agreement with its bank or financial institution that processes credit or debit card payments on behalf of Bidder (Merchant Acquirer). The Authority is not responsible for any agreed upon terms between Bidder and Bidder's Merchant Acquirer. Bidder will receive a reverse discount of 75 basis points from Authority if Bidder does not utilize the Large Ticket Vendor program with its Merchant Acquirer. The Authority's reverse discount is whereby the Authority will give back to the Bidder .75% of the Merchant services fees to the Bidder for not utilizing the Large Ticket Vendor Program. The Authority reserves the right to suspend or discontinue the reverse discount in the event Bidder consistently overcharges Authority.

OR

B. Bidder also has the option to receive payments via Automated Clearing House (ACH). Payment will be issued within 20 days after Authority's verification and approval of a Pay Application. Authority may reject a Pay Application or correct the Pay Application when errors are found. Bidder retains the right to request a review of the rejected or corrected Pay Application. Any further adjustment to the Pay Application resulting from the review will be made in the next billing period.

Bidder may at any time during the term of this Contract elect to change its payment method to ePayables upon written notice to the Assistant Vice President of Planning and Development and the completion of Authority's ePayables application process. If the payment method is changed to ePayables, the information and process described above in Paragraph A, ePayables, will apply.

Please select one of the following electronic payment methods based on the information provided above:

1. ePayables: (Choose only one on this category)

ePayables with Authority Reverse Discount.

ePayables under the Large Ticket Vendor Program.

OR

2. ACH:

Bidder would like to receive payments via ACH.



Signature

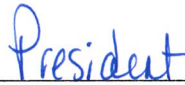

Title

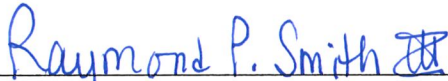

Printed Name



Date

END OF SECTION

SECTION 00510 - CONTRACT

This **CONTRACT** is made and entered into this 3rd day of August, 2017, by and between Smith Industries, Inc., hereinafter designated as the **Contractor**, and the **Hillsborough County Aviation Authority**, Tampa, Florida, hereinafter referred to as the **Owner**.

WITNESSETH:

CONTRACTOR, agrees with the Owner to the following:

1. THAT THE CONTRACTOR will provide the materials and labor specified and perform, in a first class manner, all Work in connection with the **PERIMETER FENCE REHABILITATION, AT PETER O. KNIGHT & PLANT CITY AIRPORTS**, in the manner and form as provided by the following Contract Documents, which are incorporated by reference and made a part hereof, as if fully contained herein:

PROJECT MANUAL entitled, **PERIMETER FENCE REHABILITATION** and dated **May 8, 2017**.

DRAWINGS entitled **PERIMETER FENCE REHABILITATION** and dated **May 8, 2017**.

ADDENDUM numbered 1 to 2, inclusive.

2. THAT THE CONTRACTOR will commence the Work within ten days of the date set by the Owner in a written Notice to Proceed and will achieve Substantial Completion of all Work under this Contract within 90 days after issuance of the Notice to Proceed.

3. The Owner hereby enters into this Contract with the Contractor in the Contract Sum amount of Three Hundred Fifty Three Thousand Two Hundred Five and Twenty Five One Hundredths Dollars (U. S.) (\$353,205.25) for the Work in accordance with the Contractor's listed unit prices and lump sums specified for the various items in the bid tabulation, acknowledged by the Contractor, and included as Attachment 1. Payments will be based solely on the unit prices and lump sums listed in Attachment 1 for the Work actually performed rather than the sums for the items specified in Attachment 1 which are based upon estimated quantities. Payments will be made upon presentation of the proper certificates to the Owner and upon terms set forth in the Contract Documents.

4. It is mutually agreed between the parties hereto that time is of the essence of this Contract, and in the event the Work has not achieved Substantial Completion by the completion date(s) or within the days herein specified, it is agreed that from any money due or to become due the Contractor or its surety, the Owner may retain the sum of Seven Hundred And No One Hundredth Dollars (\$700.00) per day, for each day thereafter, Sundays and holidays included, that the Work remains incomplete, not as a penalty but as liquidation of a reasonable portion of damages that will be incurred by the Owner by failure of the Contractor to complete the Work within the time(s) stipulated. The Parties agree that assessment of actual damages at the time this Contract is made is uncertain. The parties agree that the sum of \$700.00 per day is reasonable. The parties agree that the liquidated damages described in this paragraph are solely for delay and loss of use.

5. It is further mutually agreed between the parties hereto that if, at any time after the execution of this Contract (including the various guarantee periods thereunder) and the Bonds hereto attached, the Owner will reasonably deem the surety or sureties of such Bond or Bonds to be unsatisfactory, or if,

for any reason, such Bond or Bonds cease to be adequate to cover the performance of the work or the prompt payment for said labor, materials, supplies and services, the Contractor will, at its own expense within five days from the date of written notice from the Owner to do so, furnish additional Bond or Bonds in such form and amount, and with such surety or sureties, as will be satisfactory to the Owner. In such event, no further payment to the Contractor will be deemed due under this Contract until such new or additional Bond or Bonds are furnished in a manner and form satisfactory to the Owner.

6. Preference to Florida State Residents: Contractor will give preference to the employment of state residents in the performance of the Work on this Project if state residents have substantially equal qualifications to those of non-residents. The term “substantially equal qualifications” means the qualifications of two or more persons among whom the Contractor cannot make a reasonable determination that the qualifications held by one person are better suited for the position than the qualifications held by the other person or persons. If required to employ state residents, Contractor must contact the Agency for Workforce Innovation to post the Contractor’s employment needs in the state’s job bank system.

7. To the maximum extent permitted by Florida law, in addition to Contractor’s obligation to provide pay for and maintain insurance as set forth elsewhere in this Contract, Contractor will indemnify and hold harmless the Authority, its members, officers, agents, employees, and volunteers from any and all liabilities, suits, claims, expenses, losses, costs, royalties, fines and damages (including but not limited to claims for attorney’s fees and court costs) caused in whole or in part by:

- A. the presence on, use or occupancy of Authority property;
- B. acts, omissions, negligence (including professional negligence and malpractice), recklessness, intentional wrongful conduct, activities, or operations;
- C. any breach of the terms of this Contract;
- D. performance, non-performance or purported performance of this Contract;
- E. violation of any law, regulation, rule or ordinance;
- F. infringement of any patent, copyright, trademark, trade dress or trade secret rights; and/or
- G. contamination of the soil, groundwater, surface water, storm water, air or the environment by fuel, gas, chemicals or any other substance deemed by the Environmental Protection Agency or other regulatory agency to be an environmental contaminant

by the Contractor or the Contractor’s officers, employees, agents, volunteers, subcontractors, invitees, or any other person directly or indirectly employed or utilized by the Contractor, regardless of whether the liability, suit, claim, expense, loss, cost, fine or damages is caused in part by the Authority, its members, officers, agents, employees or volunteers or any other indemnified party. This indemnity obligation expressly applies, and shall be construed to include, any and all claim(s) caused in part by the negligence, acts of omissions of the Owner, its members, officers, agents, employees, and volunteers.

8. In addition to the duty to indemnify and hold harmless, Contractor will have the separate and independent duty to defend the Authority, its members, officers, agents, employees, and volunteers from all suits, claims or actions of any nature seeking damages, expenses, losses, costs, royalties, fines or attorney’s fees in the event the suit, claim, or action of any nature arises in whole or in part from:

- A. the presence on, use or occupancy of Authority property;
- B. acts, omissions, negligence (including professional negligence and malpractice), recklessness, intentional wrongful conduct, activities, or operations;
- C. any breach of the terms of this Contract;
- D. performance, non-performance or purported performance of this Contract;
- E. violation of any law, regulation, rule, order, decree or ordinance;
- F. infringement of any patent, copyright, trademark, trade dress or trade secret rights; and/or
- G. contamination of the soil, groundwater, surface water, storm water, air or the environment by fuel, gas, chemicals or any other substance deemed by the Environmental Protection Agency or other regulatory agency to be an environmental contaminant

by the Contractor or the Contractor's officers, employees, agents, volunteers, subcontractors, invitees, or any other person directly or indirectly employed or utilized by the Contractor regardless of whether it is caused in part by the Authority, its members, officers, agents, employees, or volunteers or any other indemnified party. This duty to defend exists immediately upon presentation of written notice of a suit, claim or action of any nature to the Contractor by a party entitled to a defense hereunder. This defense obligation expressly applies, and shall be construed to include, any and all claim(s) caused in part by the negligence, acts of omissions of the Owner, its members, officers, agents, employees, and volunteers.

9. If the above indemnity or defense provisions or any part of the above indemnity or defense provisions are limited by Fla. Stat. § 725.06(2)-(3) of Fla. Stat. § 725.08, then with respect to the part so limited, Contractor agrees to the following: To the maximum extent permitted by Florida law, Contractor will indemnify and hold harmless the Authority, its members, officers, agents, employees, and volunteers from any and all liabilities, damages, losses, and costs, including, but not limited to, reasonable attorneys' fee, to the extent caused by the negligence, recklessness, or intentional wrongful conduct of the Contractor and persons employed or utilized by the Contractor in the performance of this Contract.

10. If the above indemnity or defense provisions or any part of the above indemnity or defense provisions are limited by Florida Statute § 725.06 (1), or any other applicable law, then with respect to the part so limited, the monetary limitation on the extent of the indemnification shall be the greater of the (i) monetary value of this Contract, (ii) coverage amount of Commercial General Liability Insurance required under the Contract or (iii) \$1,000,000.00. Otherwise, the obligations of this Article will not be limited by the amount of any insurance required to be obtained or maintained under this Contract.

11. Contractor's obligations to defend and indemnify as described in this Contract will survive the expiration or earlier termination of this Contract until it is determined by final judgment that any suit, claim or other action against the Owner, its members, officers, agents, employees, and volunteers is fully and finally barred by the applicable statute of limitations or repose.

12. Nothing in this Contract will be construed as a waiver of any immunity from or limitation of liability the Owner, or its members, officers, agents, employees, and volunteers may have under the doctrine of sovereign immunity under common law or statute.

13. The Owner and its members, officers, agents, employees, and volunteers reserve the right, at their option, to participate in the defense of any suit, without relieving Contractor of any of its obligations under this Article.

14. If Paragraphs 7-13 or any part of Paragraphs 7-13 is deemed to conflict in any way with any law, the Paragraph or part of the Paragraph will be considered modified by such law to remedy the conflict.

15. **THIRD PARTY BENEFICIARY CLAUSE.** It is specifically agreed between the parties executing the Contract that it is not intended by any of the provisions of any part of the Contract to create in the public or any member thereof any rights as a third party beneficiary or to authorize anyone not a party to the Contract to maintain a suit for personal injuries or property damage pursuant to the terms or provisions of the Contract.

16. This Contract will be terminated in accordance with Florida Statute Section 287.135(3) if it is found that Contractor submitted a false Scrutinized Company Certification as provided in Florida Statute Section 287.135(5), or has been placed on the Scrutinized Companies with Activities in Sudan List or the Scrutinized Companies with Activities in the Iran Petroleum Energy Sector List created pursuant to Florida Statute Section 215.473.

17. **CHAPTER 119, FLA. STATUTE REQUIREMENTS**

**IF THE CONTRACTOR HAS QUESTIONS REGARDING THE APPLICATION OF CHAPTER 119, FLORIDA STATUTES, TO THE CONTRACTOR'S DUTY TO PROVIDE PUBLIC RECORDS RELATING TO THIS CONTRACT, CONTACT THE CUSTODIAN OF PUBLIC RECORDS AT:
(813) 870-8721, ADMCENTRALRECORDS@TAMPAAIRPORT.COM,
HILLSBOROUGH COUNTY AVIATION AUTHORITY, P.O. BOX 22287, TAMPA FL 33622.**

Contractor agrees in accordance with Florida Statute Section 119.0701 to comply with public records laws including the following:

- a. Keep and maintain public records required by the Owner in order to perform the Work contemplated by this Contract.
- b. Upon request from the Owner's custodian of public records, provide the Owner with a copy of the requested records or allow the records to be inspected or copied within a reasonable time at a cost that does not exceed the cost provided in Chapter 119 Fla. Stat. or as otherwise provided by law.
- c. Ensure that public records that are exempt or confidential and exempt from public records disclosure requirements are not disclosed except as authorized by law for the duration of the Contract Term and following completion of the Contract.
- d. Upon completion of this Contract, keep and maintain public records required by the Owner to perform the Work. Contractor shall meet all applicable requirements for retaining public records. All records stored electronically must be provided to the Owner, upon request from the

Owner's custodian of public records, in a format that is compatible with the information technology systems of the Owner.

18. Press releases or other specialized publicity documents, including the Contractor's advertising news bulletins, which are related to this Contract and are intended by the Contractor for the press, broadcasting, or television, will be drawn up in consultation with the Owner. Except as otherwise required by law or regulation, the Contractor will not release or distribute any materials or information relating to this Contract or containing the name of the Owner or any of its employees or Board Members without prior written approval by an authorized representative of the Owner. Contractor shall require all consultants, subcontractors and suppliers of any tier to comply with this paragraph.

19. Prohibited Interest

The Contractor represents that, in connection with this Contract or any property included or planned to be included in this Contract, it has not entered into a contract or arrangement with any officer, director or employee of the Owner, or any business entity of which the officer, director or employee of the officer's, director's or employee's spouse or child is an officer, partner, director, or proprietor or in which such officer, director or employee or the officer's director's or employee's spouse or child, or any combination of them, has a material interest.

"Material Interest" means direct or indirect ownership of more than 5 percent of the total assets or capital stock of any business entity.

The Contractor represents that, in connection with this Contract or any property included or planned to be included in this Contract, it has not entered into a contract or arrangement with any person or entity who at any time during the immediately preceding two years was an officer, director or employee of the Owner.

The provisions of this subsection shall not be applicable to any agreement between the Owner and its fiscal depositories, any agreements for utility services the rates for which are fixed or controlled by the government, or any agreement between the Owner and an agency state of government.

The following provision is made a part of this Contract and will be inserted in each of the Contractor's subcontracts:

"No member, officer, or employee of the Hillsborough County Aviation Authority during their tenure or for two years thereafter will have any interest, direct or indirect, in this Contract or the proceeds thereof."

20. Nondiscrimination

A. Compliance with Nondiscrimination Requirements

During the performance of this Contract, the Contractor, for itself, its assignees, and successors in interest (hereinafter referred to as the "Contractor") agrees as follows:

1. Compliance with Regulations: The Contractor (hereinafter includes subcontractors and consultants) will comply with the Title VI List of Pertinent Nondiscrimination Statutes and Authorities, as they may be amended from time to time, which are herein incorporated by reference and made a part of this Contract.

2. Nondiscrimination: The Contractor, with regard to the work performed by it during the Contract, will not discriminate on the grounds of race, color, or national origin in the selection and retention of subcontractors, including procurements of materials and leases of equipment. The Contractor will not participate directly or indirectly in the discrimination prohibited by the Acts and the Regulations, including employment practices when the Contract covers any activity, project, or program set forth in Appendix B of 49 CFR part 21.

3. Solicitations for Subcontracts, Including Procurements of Materials and Equipment: In all solicitations, either by competitive bidding, or negotiation made by the Contractor for work to be performed under a subcontract, including procurements of materials, or leases of equipment, each potential subcontractor or supplier will be notified by the Contractor of the Contractor's obligations under this Contract and the Acts and the Regulations relative to Nondiscrimination on the grounds of race, color, or national origin.

4. Information and Reports: The Contractor will provide all information and reports required by the Acts, the Regulations, and directives issued pursuant thereto and will permit access to its books, records, accounts, other sources of information, and its facilities as may be determined by the Owner or the Federal Aviation Administration to be pertinent to ascertain compliance with such Acts, Regulations, and instructions. Where any information required of Contractor is in the exclusive possession of another who fails or refuses to furnish the information, the Contractor will so certify to the Owner or the Federal Aviation Administration, as appropriate, and will set forth what efforts it has made to obtain the information.

5. Sanctions for Noncompliance: In the event of Contractor's noncompliance with the Nondiscrimination provisions of this Contract, the Owner will impose such contract sanctions as it or the Federal Aviation Administration may determine to be appropriate, including, but not limited to:

- a. Withholding payments to the Contractor under the Contract until the Contractor complies; and/or
- b. Cancelling, terminating, or suspending the contract, in whole or in part.

6. Incorporation of Provisions: The Contractor will include the provisions of paragraphs one through five in every subcontract, including procurements of materials and leases of equipment, unless exempt by the Acts, the Regulations and directives issued pursuant thereto. The Contractor will take action with respect to any subcontract or procurement as the Owner or the Federal Aviation Administration may direct as a means of enforcing such provisions including sanctions for noncompliance. Provided, that if the Contractor becomes involved in or is threatened with litigation by a subcontractor or supplier because of such direction, the Contractor may request the Owner to enter into any litigation to protect the interests of the Owner. In addition, the Contractor may request the United States to enter into the litigation to protect the interests of the United States.

B. Title VI List of Pertinent Nondiscrimination Authorities

During the performance of this Contract, the Contractor, for itself, its assignees, and successors in interest agrees to comply with the following nondiscrimination statutes and authorities; including but not limited to:

1. Title VI of the Civil Rights Act of 1964 (42 U.S.C. § 2000d et seq., 78 stat. 252), (prohibits discrimination on the basis of race, color, national origin);
2. 49 CFR part 21 (Non-discrimination In Federally-Assisted Programs of The Department of Transportation—Effectuation of Title VI of The Civil Rights Act of 1964);
3. The Uniform Relocation Assistance and Real Property Acquisition Policies Act of 1970, (42 U.S.C. § 4601), (prohibits unfair treatment of persons displaced or whose property has been acquired because of Federal or Federal-aid programs and projects);
4. Section 504 of the Rehabilitation Act of 1973, (29 U.S.C. § 794 et seq.), as amended, (prohibits discrimination on the basis of disability); and 49 CFR part 27;
5. The Age Discrimination Act of 1975, as amended, (42 U.S.C. § 6101 et seq.), (prohibits discrimination on the basis of age);
6. Airport and Airway Improvement Act of 1982, (49 USC § 471, Section 47123), as amended, (prohibits discrimination based on race, creed, color, national origin, or sex);
7. The Civil Rights Restoration Act of 1987, (PL 100-209), (Broadened the scope, coverage and applicability of Title VI of the Civil Rights Act of 1964, The Age Discrimination Act of 1975 and Section 504 of the Rehabilitation Act of 1973, by expanding the definition of the terms “programs or activities” to include all of the programs or activities of the Federal-aid recipients, sub-recipients and contractors, whether such programs or activities are Federally funded or not);
8. Titles II and III of the Americans with Disabilities Act of 1990, which prohibit discrimination on the basis of disability in the operation of public entities, public and private transportation systems, places of public accommodation, and certain testing entities (42 U.S.C. §§ 12131 – 12189) as implemented by Department of Transportation regulations at 49 CFR parts 37 and 38;
9. The Federal Aviation Administration’s Non-discrimination statute (49 U.S.C. § 47123) (prohibits discrimination on the basis of race, color, national origin, and sex);
10. Executive Order 12898, Federal Actions to Address Environmental Justice in Minority Populations and Low-Income Populations, which ensures nondiscrimination against minority populations by discouraging programs, policies, and activities with disproportionately high and adverse human health or environmental effects on minority and low-income populations;
11. Executive Order 13166, Improving Access to Services for Persons with Limited English Proficiency, and resulting agency guidance, national origin discrimination includes discrimination because of limited English proficiency (LEP). To ensure compliance with Title VI, Contractor must take reasonable steps to ensure that LEP

persons have meaningful access to Contractor's programs (70 Fed. Reg. at 74087 to 74100); and

12. Title IX of the Education Amendments of 1972, as amended, which prohibits Contractor from discriminating because of sex in education programs or activities (20 U.S.C. 1681 et seq).

C. Duration: Contractor must comply with this section during the period during which Federal financial assistance is extended to Owner, except where the Federal financial assistance is to provide, or is in the form of, personal property, or real property, or interest therein, or structures or improvements thereon, in which case this provision obligates the Contractor for the longer of the following periods:

1. So long as the airport is used as an airport, or for another purpose involving the provision of similar services or benefits; or
2. So long as the Owner retains ownership or possession of the property.

REMAINDER OF PAGE LEFT BLANK

IN WITNESS WHEREOF, the parties hereto have set their hands and corporate seals by their proper officers, duly authorized to do so;

By the Contractor this _____ day of _____, 201__.

ATTEST:

SMITH INDUSTRIES, INC.

By: _____

Title: _____

Print Name

Print Address

Signed, sealed, and delivered
in the presence of:

Witness

Print Name

Witness

Print Name

Notary for Smith Industries, Inc.

STATE OF _____

COUNTY OF _____

The foregoing instrument was acknowledged before me this ____ day of _____, 201__
by _____ in the capacity of _____, of

_____ a _____
(Name of organization or company, if any) (Corporation / Partnership / Sole Proprietor / Other)

on _____ behalf.

(Its / His / Her) (They are / He is / She is) (Personally known to me / not personally known to me)

_____ and _____ take an oath.

and has produced the following document of identification) (they / he / she) (did / did not)

(Seal of Notary)

Signature of Notary

By the Authority this _____ day of _____, 201__.

HILLSBOROUGH COUNTY AVIATION AUTHORITY

(Affix Corporate Seal)

By: _____
Robert I. Watkins, Chairman

ATTEST:

Victor D. Crist, Secretary

Signed, sealed, and delivered
in the presence of:

Witness

Print Name

Witness

Print Name

LEGAL FORM APPROVED AS TO FORM FOR
LEGAL SUFFICIENCY:

By: 
Michael T. Kamprath, Assistant General Counsel

Notary for Hillsborough County Aviation Authority

STATE OF FLORIDA
COUNTY OF HILLSBOROUGH

The foregoing instrument was acknowledged before me this ____ day of _____, 201__,
by Robert I. Watkins, in the capacity of Chairman, and by Victor D. Crist, in the capacity of Secretary,
Hillsborough County Aviation Authority, a public body corporate under the laws of the State of Florida,
on its behalf. They are personally known to me and they did not take an oath.

Signature of Notary

Print, Type, or Stamp Commissioned Name of
Notary

END OF SECTION

ATTACHMENT 1

Perimeter Fence Rehabilitation

HCAA Project No. 6440 17

Plant City Airport and Peter O. Knight Airport

Hillsborough County Aviation Authority

Bid Item Number	Item Description and Bid Price Per Unit (In Words)	Bid Price Per Unit (In Numbers)	Est Qty	Unit	Total Amount Per Item Unit Price Times Est Qty
P-100-1	Mobilization (Including Safety and Security)				
	Five Thousand Nine Hundred Nine Dollars Zero Cents	\$ 5,909.00	1	LS	\$ 5,909.00
	<i>Bid Price Per Unit In Words</i>	<i>In Numbers</i>			
F-162-1	Chain-Link Fence Removal				
	Two Dollars Zero Cents	\$ 2.00	10,800	LF	\$ 21,600.00
	<i>Bid Price Per Unit In Words</i>	<i>In Numbers</i>			
F-162-2	6' Chain-Link Fence, Black Vinyl Coated with/without 3 Strand Barbed Wire				
	Seventeen Dollars Forty Five Cents	\$ 17.45	8,255	LF	\$ 144,049.75
	<i>Bid Price Per Unit In Words</i>	<i>In Numbers</i>			
F-162-3	6' Chain-Link Fence, Galvanized with 3 Strand Barbed Wire				
	Thirteen Dollars Eighty Cents	\$ 13.80	2,425	LF	\$ 33,465.00
	<i>Bid Price Per Unit In Words</i>	<i>In Numbers</i>			
F-162-4	Swing Gate (Plant City Airport), Size Varies				
	One Thousand Five Hundred Eighty Two Dollars Zero Cents	\$ 1,582.00	1	LS	\$ 1,582.00
	<i>Bid Price Per Unit In Words</i>	<i>In Numbers</i>			
F-162-5	Swing Gate (Peter O. Knight Airport), Size Varies				
	Thirteen Thousand Six Hundred Seventeen Dollars Zero Cents	\$ 13,617.00	1	LS	\$ 13,617.00
	<i>Bid Price Per Unit In Words</i>	<i>In Numbers</i>			
F-162-6	Fence Bottom Regrading				
	Two Thousand Two Hundred Fifty Dollars Zero Cents	\$ 2,250.00	1	LS	\$ 2,250.00
	<i>Bid Price Per Unit In Words</i>	<i>In Numbers</i>			
F-162-7	Fence Signage				
	Twelve Thousand Nine Hundred Twenty Two Dollars Zero Cents	\$ 12,922.00	1	LS	\$ 12,922.00
	<i>Bid Price Per Unit In Words</i>	<i>In Numbers</i>			
F-162-8	Swing Gate Hinge Replacement (Double Leaf Gate)				
	Three Hundred Six Dollars Zero Cents	\$ 306.00	3	EA	\$ 918.00
	<i>Bid Price Per Unit In Words</i>	<i>In Numbers</i>			
T-101-1	Clearing, 10' Wide Along Fence Alignment				

Bid Item Number	Item Description and Bid Price Per Unit <i>(In Words)</i>	Bid Price Per Unit <i>(In Numbers)</i>	Est Qty	Unit	Total Amount Per Item <i>Unit Price Times Est Qty</i>
	Twenty Six Dollars Seventy Cents	\$ 26.70	3,250	LF	\$ 86,775.00
	<i>Bid Price Per Unit In Words</i>	<i>In Numbers</i>			
T-101-2	Trimming, Above Existing Fence Alignment				
	Seven Dollars Ten Cents	\$ 7.10	1,425	LF	\$ 10,117.50
	<i>Bid Price Per Unit In Words</i>	<i>In Numbers</i>			
Sub-total for all Bid Items not including Owner's Allowance					
	Three Hundred Thirty Three Thousand Two Hundred Five Dollars Twenty Five Cents				\$ 333,205.25
	<i>Bid Price Per Unit In Words</i>				<i>In Numbers</i>
Owner's Allowance					
	Twenty Thousand Dollars Zero Cents	\$ 20,000.00	1	Allow	\$ 20,000.00
	<i>Bid Price Per Unit In Words</i>	<i>In Numbers</i>			<i>In Numbers</i>
Total Bid Amount including Owner's Allowance					
	Three Hundred Fifty Three Thousand Two Hundred Five Dollars Twenty Five Cents				\$ 353,205.25
	<i>Total Bid Amount in Words</i>				<i>In Numbers</i>

W/MBE Participation Commitment		
	A	B
Total W/MBE Commitment Amount from Validated Letter of Intent	\$0.00	
Total Bid Amount		\$353,205.25
DBE Commitment Percentage (equals A/B)	0.00%	

NOTE:

The W/MBE Commitment percentage is established in accordance with the Owner's W/MBE Policy as stated in Section 00100 INSTRUCTIONS TO BIDDERS and supported by the Letter(s) of Intent submitted by the Contractor with the bid. The Total W/MBE Commitment Percentage may only be modified by Change Order.

The undersigned accepts as true and correct the Total Bid Amount and W/MBE Commitment Percentage calculation contained in this Bid Tabulation.

Name of Contractor: Smith Industries, Inc.

Signature of Contractor: _____

Raymond P. Smith III

Title: President

Date: _____

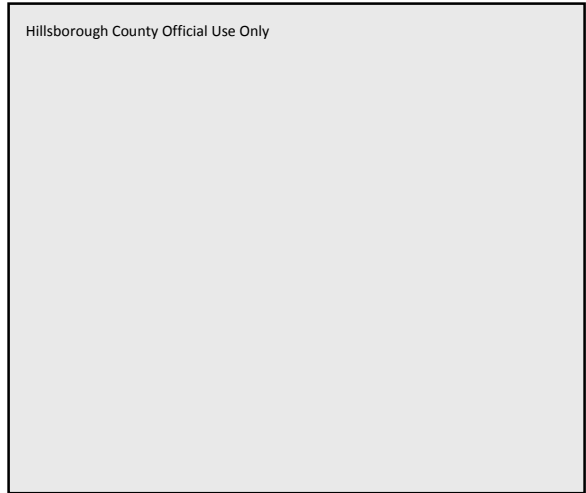

SECTION 00610
COMMON LAW PERFORMANCE BOND

BOND NO. _____
STATE OF _____
COUNTY OF _____

BY THIS BOND, Smith Industries Inc. whose principal business address is 4699 110th Avenue N. Clearwater, FL 33762, business phone number (727) 573-5440 is as Principal, hereinafter "Contractor", and _____, whose principal business address is _____, business phone number is _____ as Surety, hereinafter "Surety", are held and firmly bound to the Hillsborough County Aviation Authority, whose principal address is P.O. Box 22287, Tampa, Florida 33622, business phone number is (813) 870-8700, as Obligee, hereinafter "Owner", in the amount of Three Hundred Fifty Three Thousand Two Hundred Five and Twenty Five One Hundredths Dollars (U. S.) (\$353,205.25) for the payment of which Contractor and Surety bind themselves, their heirs, executors, administrators, successors, and assigns, jointly and severally, as provided herein.

WHEREAS, Contractor has by written Contract dated August 3, 2017 entered into an agreement with Owner for **AUTHORITY PROJECT NUMBER 6440 17, PERIMETER FENCE REHABILITATION at PETER O. KNIGHT & PLANT CITY AIRPORTS** to perform in accordance with the Contract, and the Contract Documents incorporated by reference in the Contract or otherwise. The Contract is incorporated by reference into this Performance Bond, hereinafter "Bond".

It is the condition of this Bond that if the Contractor performs its Contract obligations (the "Work"), then the Surety's obligations under this Bond are null and void; otherwise the Surety's obligations will remain in full force and effect.

The Contractor will perform, carry out and abide by all the terms, conditions and provisions of the Contract and complete the Work in accordance with its terms. If the Contractor fails to perform its Contract obligations, it will be the duty of the Surety to promptly assume responsibility for performance of the Contract including but not limited to completion of the Work. The Surety must and does hereby agree to indemnify the Owner and hold it harmless of, from and against any and all liability, loss, cost, damage, expense, attorney fees, including appellate proceedings, engineering and architectural fees or other professional services which the Owner may incur or which may accrue or be imposed upon the Owner by reason of any negligence, default, breach or misconduct on the part of the Contractor, Contractor's agents, servants, subcontractors or employees, in, about, or on account of the Work or performance of the Contract. Surety will be required to repay and reimburse the Owner, promptly upon demand, all sums of money including, but not limited to, attorney, architect, engineer and any other professional fees reasonably paid out or expended by the Owner on account of the failure or refusal of the Contractor to carry out, perform, or comply with any of the terms, conditions or provisions of the Contract including, but not limited to, the guarantee of the Work and materials furnished under the Contract for the time specified in the Contract.

The Surety hereby stipulates and agrees that any modification, omission, or addition, in or to the terms of the Contract, including the Contract Documents, will not affect the obligation of the Surety under this Bond.

Signed and sealed this _____ day of _____, 20____.

CONTRACTOR MUST INDICATE WHETHER CORPORATION, PARTNERSHIP, COMPANY, (OR INDIVIDUAL). THE PERSON SIGNING FOR THE CONTRACTOR WILL SIGN HIS/HER OWN NAME AND SIGN CORPORATE TITLE. WHEN THE PERSON SIGNING FOR A CORPORATION IS OTHER THAN THE PRESIDENT OR VICE PRESIDENT, HE/SHE MUST FURNISH A CORPORATE RESOLUTION SHOWING HIS/HER AUTHORITY TO BIND THE CORPORATION.

(Affix Contractor's Corporate Seal)

_____	By: _____
Name of Contractor	(Signature)
Type Name and Title Below:	Address: _____
_____	_____
_____	_____
Telephone Number	Fax Number

(Affix Surety's Corporate Seal)

_____	_____
Name of Surety	
By: _____	By: _____
Attorney in Fact for Surety (Signature)	Florida Licensed Agent (Signature)
Type name of Attorney in Fact: _____	Type name of Fla. Licensed Agent: _____
Attorney in Fact Address: _____	License Number _____
Attorney in Fact Address: _____	Agent Address: _____
_____	_____
_____	_____
Telephone Number	Fax Number
_____	_____
Telephone Number	Fax Number

(ATTACH "SURETY'S BOND AFFIDAVIT" ON COPY OF FORM BOUND IN THESE SPECIFICATIONS).
(ATTACH "POWER OF ATTORNEY" FOR SURETY COMPANY REPRESENTATIVE).

Hillsborough County Aviation Authority

THE FOREGOING BOND IS HEREBY APPROVED FOR LEGAL SUFFICIENCY:

By: _____ By: _____

Michael Kamprath, Assistant General Counsel

THIS BOND MUST BE RECORDED IN THE PUBLIC RECORDS OF HILLSBOROUGH COUNTY FLORIDA PRIOR TO COMMENCING ANY WORK UNDER THE CONTRACT.

SECTION 00620
STATUTORY PAYMENT BOND

BOND NO. _____

STATE OF _____

COUNTY OF _____

BY THIS BOND, Smith Industries Inc. whose principal business address is 4699 110th Avenue N. Clearwater, FL 33762, business phone number (727) 573-5440 is as Principal, hereinafter "Contractor", and _____, whose principal business address is _____, business phone number is _____ as Surety, hereinafter "Surety", are held and firmly bound to the Hillsborough County Aviation Authority, whose principal address is P.O. Box 22287, Tampa, Florida 33622, business phone number is (813) 870-8700, as Obligee, hereinafter "Owner", in the amount of Three Hundred Fifty Three Thousand Two Hundred Five and Twenty Five One Hundredths Dollars (U. S.) (\$353,205.25) for the payment of which Contractor and Surety bind themselves, their heirs, executors, administrators, successors, and assigns, jointly and severally, as provided herein.

THE CONDITION OF THIS BOND is that if Contractor:

1. Performs the Contract dated August 3, 2017, between Contractor and Owner for **AUTHORITY PROJECT NUMBER 6440 17, PERIMETER FENCE REHABILITATION at PETER O. KNIGHT & PLANT CITY AIRPORTS**, the Contract being made a part of this Bond by reference, at the times and in the manner prescribed in the Contract; and
2. Promptly makes payments to all claimants, as defined in Section 255.05(1), Florida Statutes, supplying Contractor with labor, materials, or supplies, used directly or indirectly by Contractor in the prosecution of the work provided for in the Contract; and
3. Pays Owner all losses, damages, expenses, costs, and attorney's fees, including appellate proceedings, that Owner sustains because of a default by Contractor under the Contract; and
4. Performs the guarantee of all work and materials furnished under the Contract for the time specified in the Contract, then this Bond is void; otherwise it remains in full force.

Any action instituted by claimant under this Bond for payment must be in accordance with the notice and time limitation provisions in Sections 255.05(2) and (10), Florida Statutes.

SECTION 00620
STATUTORY PAYMENT BOND

Any changes in or under the Contract Documents and compliance or non-compliance with any formalities connected with the Contract or the changes does not affect Surety's obligation under this Bond.

Signed and sealed this _____ day of _____, 201__.

CONTRACTOR MUST INDICATE WHETHER CORPORATION, PARTNERSHIP, COMPANY, (OR INDIVIDUAL). THE PERSON SIGNING FOR THE CONTRACTOR WILL SIGN HIS/HER OWN NAME AND SIGN CORPORATE TITLE. WHEN THE PERSON SIGNING FOR A CORPORATION IS OTHER THAN THE PRESIDENT OR VICE PRESIDENT, HE/SHE MUST FURNISH A CORPORATE RESOLUTION SHOWING HIS/HER AUTHORITY TO BIND THE CORPORATION.

(Affix Contractor's Corporate Seal)

_____	By: _____
Name of Contractor	(Signature)
Type Name and Title Below:	Address: _____
_____	_____
_____	_____
Telephone Number	Fax Number

(Affix Surety's Corporate Seal)

_____	_____
Name of Surety	
By: _____	By: _____
Attorney in Fact for Surety (Signature)	Florida Licensed Agent (Signature)
Type name of Attorney in Fact: _____	Type name of Fla. Licensed Agent: _____
Attorney in Fact Address: _____	License Number: _____
_____	Agent Address: _____
_____	_____
Telephone Number	Fax Number
Telephone Number	Fax Number

(ATTACH "SURETY'S BOND AFFIDAVIT" ON COPY OF FORM BOUND IN THESE SPECIFICATIONS).
(ATTACH "POWER OF ATTORNEY" FOR SURETY COMPANY REPRESENTATIVE).

Hillsborough County Aviation Authority

By: _____

THE FOREGOING BOND IS HEREBY APPROVED FOR LEGAL SUFFICIENCY:

By: _____
Michael Kamprath, Assistant General Counsel

THIS BOND MUST BE RECORDED IN THE PUBLIC RECORDS OF HILLSBOROUGH COUNTY FLORIDA PRIOR TO COMMENCING ANY WORK UNDER THE CONTRACT.

SECTION 00620
STATUTORY PAYMENT BOND

STATE OF _____
COUNTY OF _____

BEFORE ME, the undersigned authority, personally appeared _____,
who being duly sworn, deposes and says that they are a duly authorized Florida agent, properly licensed
under the laws of the State of Florida, to represent _____,
a company authorized to make corporate surety bonds under the laws of the State of Florida (the "Surety").

Said _____ further certifies that as agent for the said Surety, they have countersigned
the attached Bond as the Florida Licensed Agent in the sum of Three Hundred Fifty Three Thousand Two
Hundred Five and Twenty Five One Hundredths Dollars (U. S.) (\$353,205.25) on behalf of Smith Industries,
Inc. to the **HILLSBOROUGH COUNTY AVIATION AUTHORITY** covering **AUTHORITY PROJECT NUMBER 6440
17, PERIMETER FENCE REHABILITATION at PETER O. KNIGHT & PLANT CITY AIRPORTS.**

Said _____ further certifies that the premium on the said Bonds is
_____, which will be paid in full directly to them as agent and included
in their regular accounts to the said Surety, and that they will receive their regular commission as agent for
the execution of said Bond and that their commission will not be divided with anyone except to
_____, who is a duly authorized insurance agent properly licensed under the laws of
the State of Florida.

SIGNED:

By: _____
Florida Licensed Insurance Agent (Signature)

Type Name or Agent Below:

Address of Agent: _____

Telephone Number: _____

FAX Number: _____

Florida License Number: _____

STATE OF _____

COUNTY OF _____

The foregoing instrument was acknowledged before me this _____ day of _____
201__, by _____ who is personally known to me or who has produced the following
identification _____, and who did/did not take an oath.

Signature of Notary
END OF SECTION

SECTION 00650 - INSURANCE REQUIREMENTS

PART 1 - GENERAL CONDITIONS

1.01 INSURANCE COVERAGE AND LIMITS

A. Contractor must maintain the following limits and coverages uninterrupted or amended through the term of this Contract. In the event the Contractor becomes in default of the following requirements, the Owner reserves the right to take whatever actions deemed necessary to protect its interests. Required liability and property insurance policies, other than Workers' Compensation/Employer's Liability and Professional Liability, will provide that the Hillsborough County Aviation Authority (HCAA) , members of the HCAA governing body, and the HCAA officers, volunteers, and employees are included as additional insureds.

1. Workers' Compensation/Employer's Liability:

The minimum limits of insurance (inclusive of any amounts provided by an umbrella or excess policy) will be:

Part One:	"Statutory"
Part Two:	
Each Accident	\$ 1,000,000.
Disease - Policy Limit	\$ 1,000,000.
Disease - Each Employee	\$ 1,000,000.

2. Commercial General Liability:

The minimum limits of insurance (inclusive of any amounts provided by an umbrella or excess policy) covering the work performed pursuant to this Contract will be the amounts specified herein. Coverage will be provided for liability resulting out of, or in connection with, ongoing operations performed by, or on behalf of, Contractor under this Contract or the use or occupancy of Owner premises by, or on behalf of, Contractor in connection with this Contract. Coverage shall be on a form no more restrictive than ISO form CG 00 01. Additional insurance coverage shall be provided on a form no more restrictive than ISO Form CG 20 10 10 01 and CG 20 37 10 01.

	Contract Specific
General Aggregate	\$ 2,000,000.
Each Occurrence	\$ 2,000,000.
Personal and Advertising Injury Each Occurrence	\$ 2,000,000.
Products/Completed Operations Aggregate	\$ 2,000,000.

3. Business Auto Liability:

Coverage will be provided for all owned, hired and non-owned vehicles. Coverage shall be provided on a form no more restrictive than ISO Form CA 00

01. The minimum limits of insurance (inclusive of any amounts provided by an umbrella or excess policy) covering the work performed pursuant to this Contract will be:

Each Occurrence - Bodily Injury and
Property Damage Combined

\$ 2,000,000.

CONTRACTUAL INSURANCE TERMS AND CONDITIONS - STANDARD PROCEDURE S250.06

This Section incorporates the Owner's Standard Procedure S250.66 and establishes the insurance terms and conditions associated with contractual insurance requirements. This Section is applicable to all Contractors with Authority contracts. Unless otherwise provided herein, any exceptions to the following conditions or changes to required coverages or coverage limits must have prior written approval from the Executive Vice President of Facilities and Administration or designee.

INSURANCE COVERAGE:

A. Procurement of Coverage:

With respect to each of the required coverages, the Contractor will, at the Contractor's expense, procure, maintain and keep in force the amounts and types of insurance conforming to the minimum requirements set forth in the Contract. Coverages will be provided by insurance companies eligible to do business in the State of Florida and having an AM Best rating of A- or better and a financial size category of VII or better. Utilization of non-rated companies or companies with AM Best ratings lower than A- or a financial size category lower than VII may be approved on a case by case basis by Risk Management.

B. Term of Coverage:

Except as otherwise specified in the contract, the insurance will commence on or prior to the effective date of the Contract and will be maintained in force throughout the duration of the Contract. Completed operations coverage may be required to be maintained on specific commercial general liability policies effective on the date of substantial completion or the termination of the Contract, whichever is earlier. If a policy is written on a claims made form, the retroactive date must be shown and this date must be before the earlier of the date of the execution of the Contract or the beginning of contract work, and the coverage must respond to all claims reported within three years following the period for which coverage is required unless stated otherwise in the Contract.

C. Reduction of Aggregate Limits:

If the aggregate limit is exhausted, the Contractor will immediately take all possible steps to have it reinstated. The general liability policies shall include a per policy endorsement providing that the limits of such insurance specified in the Contract shall apply solely to the work under the Contract without erosion of such limits by other claims or occurrences.

1. Cancellation Notice

Each of the insurance policies will be specifically endorsed to require the insurer to provide the Owner with 30 days written notice (or 10 days for non-payment of premium) prior to the cancellation of the policy. The endorsement will specify that such notice will be sent to:

Hillsborough County Aviation Authority
Attn.: Chief Executive Officer
Tampa International Airport
Post Office Box 22287
Tampa, Florida 33622

D. No waiver by approval/disapproval:

The Owner accepts no responsibility for determining whether the Contractor's insurance is in full compliance with the insurance required by the Contract. Neither the approval by the Owner nor the failure to disapprove the insurance furnished by the Contractor will relieve the Contractor of their full responsibility to provide the insurance required by the Contract.

E. Future Modifications – Changes in Circumstances:

1. Changes in Coverages and Required Limits of Insurance

The coverages and minimum limits of insurance required by the Contract are based on circumstances in effect at the inception of the Contract. If, in the opinion of the Owner, circumstances merit a change in such coverages or minimum limits of insurance required by the Contractor, the Owner may change the coverages and minimum limits of insurance required, and the Contractor will, within 60 days of receipt of written notice of a change in the coverages and minimum limits required, comply with such change and provide evidence of such compliance in the manner required by the Contract. Provided, however, that no change in the coverages or minimum limits of insurance required will be made until at least two years after inception of the Contract. Subsequent changes in the coverages or minimum limits of insurance will not be made until at least two years after any prior change unless extreme conditions warrant such change and are agreeable to both parties.

If, in the opinion of the Owner, compliance with the insurance requirements is not commercially practicable for the Contractor, at the written request of the Contractor, the Owner may, at its sole discretion and subject to any conditions it deems appropriate, relax or temporarily suspend, in whole or in part, the insurance requirements which would otherwise apply to the Contractor. Any such modification will be subject to the prior written approval of the Executive Vice President of Facilities and Administration or designee, and subject to the conditions of such approval.

F. Proof of Insurance – Insurance Certificate:

1. Prior to Work, Use or Occupancy of Owner's Premises

The Contractor will not commence work, use or occupy Owner's premises in connection with the Contract until the required insurance is in force, preliminary evidence of

insurance acceptable to the Owner has been provided to the Owner, and the Owner has granted permission to the Contractor to commence work, use or occupy the premises in connection with the Contract.

2. Proof of Insurance Coverage

As preliminary evidence of compliance with the insurance required by the Contract, the Contractor will furnish the Owner with a certificate(s) of insurance satisfactory to the Owner. This certificate must be signed by an authorized representative of the insurer. If requested by the Owner, the Contractor will, within 15 days after receipt of written request from the Owner, provide the Owner, or make available for review, certificates of insurance, copies of required endorsements and/or a certified complete copy of the policies of insurance. The Contractor may redact those portions of the insurance policies that are not relevant to the coverage required by the Contract. The Contractor will provide the Owner with renewal or replacement evidence of insurance, acceptable to the Owner, prior to expiration or termination of such insurance.

The insurance certificate must:

- a. Indicate that, to the extent required by the Contract:
 - i. the Owner, members of the Owner's governing body, and the Owner's officers, volunteers and employees are included as Additional Insureds on all policies other than workers compensation and professional liability, and
 - ii. the insurers for all policies have waived their subrogation rights against the Owner;
- b. Indicate that the certificate has been issued in connection with the Contract;
- c. Indicate the amount of any deductible or self-insured retention applicable to all coverages;
- d. Identify the name and address of the certificate holder as:

Hillsborough County Aviation Authority
Attn.: Chief Executive Officer
Tampa International Airport
Post Office Box 22287
Tampa, Florida 33622
and;
- e. Be signed and dated using approved methods by an individual who is an authorized representative of each insurer, whose insurance is the subject of the certificate and who is authorized by each such insurer to issue the certificate of insurance as modified. Facsimile signatures are acceptable.

G. Deductibles / Self Insurance:

1. All property and builders risk deductibles, as well as all self-insured retentions or any schemes other than a fully insured program, must be approved by the Executive Vice President of Facilities and Administration or designee. The Contractor agrees to provide all documentation necessary for the Owner to review the deductible or alternative program.
2. The Contractor will pay on behalf of the Owner, or any member of the Owner's governing body or any officer or employee of the Owner, any deductible or self-insured retention (SIR) which, with respect to the required insurance, is applicable to any claim by or against the Owner, or any member of the Owner's governing body, or any officer or employee of the Owner.
3. The Agreement by the Owner to allow the use of a deductible or self-insurance program will be subject to periodic review by the Risk Manager. If, at any time, the Owner deems that the continued use of a deductible or self-insurance program by the Contractor should not be permitted, the Owner may, upon 60 days written notice to the Contractor, require the Contractor to replace or modify the deductible or self-insurance in a manner satisfactory to the Owner.
4. Any deductible amount or SIR program will be included and clearly described on the certificate prior to any approval by the Owner. This is to include fully insured programs as to a zero deductible per the policy. Owner reserves the right to deny any certificate not in compliance with this requirement.

H. Contractor's Insurance Primary:

The Contractor's required insurance will apply on a primary basis. Any insurance maintained by the Owner will be excess and will not contribute to the insurance provided by or on behalf of the Contractor.

I. Applicable Law:

With respect to any contract entered into by the Owner with a value exceeding \$10,000,000, if any required policy is: (i) issued to a policyholder outside of Florida or (ii) contains a "choice of law" or similar provision stating that the law of any state other than Florida shall govern disputes concerning the policy, then such policy must be endorsed so that Florida law (including but not limited to Part II of Chapter 627 of the Florida Statutes) will govern any and all disputes concerning the policy in connection with claims arising out of work performed pursuant to the Contract.

J. Waiver of Subrogation:

The Contractor, for itself and on behalf of its insurers, to the fullest extent permitted by law without voiding the insurance required by the Contract, waives all rights against the Owner, members of the Owner's governing body and the Owner's officers, volunteers and employees, for damages or loss to the extent covered and paid for by any insurance maintained by the Contractor.

K. Contractor's Failure to Comply with Insurance Requirements:

1. Owner's Right to Procure Replacement Insurance

If, after the inception of the Contract, the Contractor fails to fully comply with the insurance requirements of the Contract, in addition to and not in lieu of any other remedy available to the Owner provided by the Contractor, insurance which provides, in whole or in part, the required insurance coverage.

2. Replacement Coverage at Sole Expense of Contractor

The entire cost of any insurance procured by the Owner will be paid by the Contractor. At the option of the Owner, the Contractor will either directly pay the entire cost of the insurance or immediately reimburse the Owner for any costs incurred by the Owner including premium and a 15% administration cost.

a. Contractor to Remain Fully Liable

Except to the extent any insurance procured by the Owner actually provides the insurance coverage required by the Contract, the Contractor will remain fully liable for full compliance with the insurance requirements in the Contract.

b. Owner's Right to Terminate, Modify, or Not Procure

Any insurance procured by the Owner is solely for the Owner's benefit and is not intended to replace or supplement any insurance coverage which otherwise would have been maintained by the Contractor. Authority is not obligated to procure any insurance pursuant to these requirements and retains the right, at its sole discretion, to terminate any such insurance which might be procured by the Owner.

END OF SECTION

SECTION 00700 – GENERAL CONDITIONS OF THE CONTRACT FOR CONSTRUCTION

PART 1 – GENERAL CONDITIONS

1.01 BASIC DEFINITIONS

A. THE CONTRACT DOCUMENTS

The Contract Documents consist of:

1. The Project Manual containing the Bidding Documents, Bonds, Affidavits, Compliance Forms, Statements, Insurance Requirements and Documents, the Contract between Owner and Contractor (herein referred to as the Contract), Conditions of the Contract (General Conditions), General Requirements and other Requirements, Reports, and Specifications.
2. The Drawings are the graphic and pictorial portions of the Contract Documents, wherever located and whenever issued, to the extent approved by Owner, showing the design, location and dimensions of the Work, and generally include plans, elevations, sections, details, models, electronic data, Building Information Modeling (BIM) schedules and diagrams.
3. All Addenda issued prior to, and all Modifications issued after, execution of the Contract.
4. A Modification is a written amendment to the Contract signed by both parties, or a Change Order, work order or written order for a minor change in the Work issued by the Owner.

B. THE CONTRACT

1. The Contract Documents form the Contract for Construction. The Contract represents the entire and integrated agreement between the parties hereto and supersedes prior negotiations, representations or agreements, either written or oral. The parties will not be bound by or be liable for any statement, representation, promise, inducement or understanding of any kind or nature not set forth herein.
2. No changes, amendments or modifications of any of the terms or conditions of the Contract will be valid unless reduced to writing and signed by both parties. The Contract may be amended or modified only by a Modification. Except as provided in Paragraph 3.18, nothing contained in the Contract Documents will be construed to create any contractual relationship (1) between the Design Professional and the Contractor, (2) between the Owner or the Design Professional and a Subcontractor or Sub-Subcontractor, (3) between the Owner and the Design Professional, or (4) between any persons or entities other than the Owner and the Contractor. The Contract will be construed in accordance with the laws of the State of Florida. In any action initiated by one party against the other, venue will lie in Hillsborough County, Florida. The Design Professional will, however, be entitled to performance and enforcement or obligations under

the Contract intended to facilitate performance of the Design Professional's duties.

- a. The Contractor will not assign, transfer, convey or otherwise dispose of the Contract or its right, title or interest in it without previous consent of the Owner which consent will not be unreasonably withheld. Owner's consent to any assignment will not relieve the Contractor of any of its agreements, responsibilities, or obligations under this Contract, and the Contractor will be and remain as fully responsible and liable for the defaults, acts, and omissions of Contractor's assignees and Subcontractors arising in connection with the performance of this Contract.
- b. Subject to the limitations upon assignment and transfer herein contained, this Contract will be binding upon and inure to the benefit of the parties hereto, their respective successors and assigns.
- c. The term "Work" means the construction and services required by the Contract Documents, whether completed or partially completed, and includes all other labor, materials, equipment and services provided or to be provided by the Contractor to fulfill the Contractor's obligations. The Work may constitute the whole or a part of the Project.

C. THE PROJECT

The Project is the total construction of which the Work performed under the Contract Documents may be the whole or a part and which may include construction by the Owner or by separate contractors.

D. THE DRAWINGS

The Drawings are the graphic and pictorial portions of the Contract Documents, wherever located and whenever issued, showing the design, location and dimensions of the Work, generally including plans, elevations, sections, details, schedules and diagrams.

E. THE SPECIFICATIONS

The Specifications are that portion of the Contract Documents consisting of the written requirements for materials, equipment, construction systems, standards and workmanship for the Work, and performance of related services.

F. THE PROJECT MANUAL

The Project Manual is the volume(s) usually assembled for the Work which may include the bidding requirements, sample forms, Conditions of the Contract and Specifications.

1.02 EXECUTION, CORRELATION AND INTENT

- A. The Contract Documents must be signed in not less than duplicate by the Owner and Contractor as provided in the Contract Documents.
- B. Execution of the Contract by the Contractor is a representation that the Contractor has visited the site, become familiar with local conditions under which the Work is to be

performed and correlated personal observations with requirements of the Contract Documents.

- C. The intent of the Contract Documents is to include all items necessary for the proper execution and completion of the Work by the Contractor. The Contract Documents are complementary and what is required by one will be as binding as if required by all. Performance by the Contractor will be required only to the extent consistent with the Contract Documents and reasonably inferable from them as being necessary to produce the intended results.
- D. Organization of the Specifications into divisions, sections and Parts, and arrangement of Drawings, will not control the Contractor in dividing the Work among subcontractors or in establishing the extent of Work to be performed by any trade.
 - 1. The Contractor and all Subcontractors will refer to all of the Drawings, including those showing primarily the Work of the mechanical, electrical and other specialized trades, and to all of the Sections of the Specifications, and will perform all Work reasonably inferable therefrom as being necessary to produce the indicated results.
- E. Unless otherwise stated in the Contract Documents, words which have well-known technical or construction industry meanings are used in the Contract Documents in accordance with such recognized meanings.
- F. If Work is required by the Drawings and Specifications in a manner which makes it impossible to produce first class Work, or should discrepancies appear among the Contract Documents, the Contractor will request an interpretation before proceeding with the Work. If the Contractor fails to make such a request, no excuse will thereafter be entertained for failure to carry out the Work in a satisfactory manner. Should conflict occur in or between the Drawings and Specifications, the Contractor is deemed to have estimated the more expensive way of doing the Work unless Contractor will have asked for and obtained a written decision before submission of Contractor's Bid as to which method or materials will be required.
- G. All Work mentioned or indicated in the Contract Documents will be performed by the Contractor as part of this Contract unless it is specifically indicated in the Contract Documents that such construction is not in the Contract. In the event of any conflict(s) among the Contract Documents, the precedence in resolving such conflict(s) will be as follows:
 - 1. General Requirements will govern over General Conditions.
 - 2. General Conditions will govern over Technical Specifications.
 - 3. Technical Specifications will govern over Drawings.
 - 4. Schedules will govern over Drawings.
 - 5. Large-scale Drawings will govern over smaller scale Drawings.
 - 6. Greater quantities will govern over lesser.
 - 7. Higher quality, as adjudged by the Owner, will govern over lesser.

(The above precedence are in numerical order and they will be construed to mean the order of precedence.)

- H. All indications or notations which apply to one of a number of similar situations, materials or processes will be deemed to apply to all such situations, materials or processes wherever they appear in the Work, except where a contrary result is clearly indicated by the Contract Documents.
- I. Where codes, standards, requirements and publications of public and private bodies are referred to in the Specifications, references will be understood to be the latest edition, including all amendments thereto, in effect on the date of receiving bids, except where otherwise indicated.
- J. Where no explicit quality or standards for materials or workmanship are established for Work, such Work is to be of good quality for the intended use and consistent with the quality of the surrounding Work and of the construction of the Project generally.
- K. All manufactured articles, materials, and equipment will be applied, installed, connected, erected, started up, tested, cleaned, and conditioned in accordance with the manufacturer's written or printed directions and instructions unless otherwise indicated in the Contract Documents.
- L. The Mechanical, Electrical and Fire Protection Drawings are diagrammatic only and are not intended to show the alignment, exact physical locations or configurations of such Work. Such Work will be installed, without additional cost to the Owner, to clear all obstructions, permit proper clearances for the Work of other trades, and present an orderly appearance where exposed. Prior to beginning such Work, the Contractor will prepare coordination drawings and complete detailed layout drawings showing the exact alignment, physical location and configuration of the mechanical, electrical and fire protection installations and demonstrating to the Owner's satisfaction that the installations will comply with the preceding sentence. Coordination drawings and complete detailed layout drawings will be submitted to the for Owner's review prior to the commencement of the Work.
- M. Exact locations of fixtures and outlets will be obtained from the Owner as provided in Subparagraph 3.02 E. before the Work is roughed in. Work installed without such information from the Owner will be relocated at the Contractor's expense.
- N. Test boring or soil test information included with the Contract Documents or otherwise made available to the Contractor was obtained by the Owner in the design of the Project or Work. The Owner does not warrant such information to the Contractor as an accurate (an exact) indication but is an approximate indication of subsurface conditions, and no claim for extra cost or extension of time resulting from reliance by the Contractor on such information will be allowed.
- O. Where the Work is to fit with existing conditions or construction not included in this Contract, the Contractor will fully and completely join the Work with such conditions or construction, unless otherwise specified.

1.03 OWNERSHIP AND USE OF DESIGN PROFESSIONAL'S DRAWINGS, SPECIFICATIONS AND OTHER DOCUMENTS

All Drawings, Specifications and other documents furnished by the Design Professional or Owner are and will remain the property of the Owner. The Drawings, Specifications and other documents prepared by the Design Professional or Owner are instruments of the Design Professional's or Owner's service through which the work to be executed by the Contractor is described. The Contractor may retain one contract record set. Neither the Contractor nor any Subcontractor, Sub-Subcontractor or material or equipment supplier will own or claim a copyright in the Drawings, Specifications and other documents prepared by the Design Professional or Owner, and unless otherwise indicated, the Design Professional or Owner will be deemed the author of them and will retain all common law, statutory, copyright and other reserved rights. All copies of them, except the Contractor's record set, will be returned or suitably accounted for to the Design Professional or Owner, on request, upon completion of the Work. The Drawings, Specifications and other documents prepared by the Design Professional or Owner, and copies thereof furnished to the Contractor, are for use solely with respect to this Project. They are not to be used by the Contractor or any Subcontractor, Sub-Subcontractor or material or equipment supplier on other projects or for additions to this Project outside the scope of the work without the specific written consent of the Owner. The Contractor, Subcontractors, Sub-Subcontractors and material or equipment suppliers are granted a limited license to use and reproduce applicable portions of the Drawings, Specifications and other documents prepared by the Design Professional or owner appropriate to and for use in the execution of their work under the Contract Documents. All copies made under this license will bear the statutory copyright notice, if any, shown on the Drawings, Specifications and other documents prepared by the Design Professional or Owner. Submittal or distribution to meet official regulatory requirements or for other purposes in connection with this Project is not to be construed as publication in derogation of the Design Professional's or Owner's copyright or other reserved rights.

1.04 CAPITALIZATION

Terms capitalized in these general conditions include those which are (1) specifically defined, (2) the titles of numbered Parts and identified references to paragraphs, subparagraphs and clauses in the document or (3) the titles of other documents published.

1.05 INTERPRETATION

In the interest of brevity the Contract Documents frequently omit modifying words such as "all" and "any" and articles such as "the" and "an," but the fact that a modifier or an article is absent from one statement and appears in another is not intended to affect the interpretation of either statement.

PART 2 – OWNER

2.01 DEFINITION

The Owner is the Hillsborough County Aviation Authority (Authority) and is referred to throughout the Contract Documents as if singular in number. The term "Owner" means Authority or the Owner's authorized representative.

2.02 INFORMATION AND SERVICES REQUIRED OF THE OWNER

- A. The Owner will make available Record Documents and Drawings pertaining to the existing buildings and/or facilities relative to this Project. The Owner does not warrant the accuracy and completeness of such Record Documents and Drawings and they are not a part of the Contract Documents.

- B. Information or services required of the Owner will be furnished by the Owner with reasonable promptness after receipt from the Contractor of a written request for such information or services.
- C. The Contractor will be furnished free of charge, one copy of the Drawings and conformed Project Manuals. Additional sets can be made from the CD provided with the conformed set.
- D. The foregoing are in addition to other duties and responsibilities of the Owner enumerated in Section 00700 –GENERAL CONDITIONS OF THE CONTRACT FOR CONSTRUCTION.

2.03 OWNER’S RIGHT TO STOP THE WORK

If the Contractor fails to correct Work which is not in accordance with the requirements of the Contract Documents as required by Paragraph 11.02 or persistently fails to carry out Work in accordance with the Contract Documents, the Owner, the Design Professional, or other authorized representatives, by written order signed personally, may order the Contractor to stop the Work, or any portion thereof, until the cause for such order has been eliminated; however, the right of the Owner to stop the Work will not give rise to a duty on the part of the Owner to exercise this right for the benefit of the Contractor or any other person or entity, except to the extent required by Subparagraph 6.01 C.

2.04 OWNER’S RIGHT TO CARRY OUT THE WORK

If the Contractor defaults or neglects to carry out the Work in accordance with the Contract Documents and fails within a seven day period after receipt of written Notice from the Owner to begin and prosecute correction of such default or neglect with diligence and promptness, the Owner may, without prejudice to other remedies the Owner may have, correct such deficiencies. In such case an appropriate change order will be issued deducting from payments then or thereafter due the Contractor the cost of correcting such deficiencies, including compensation for the Design Professional’s or Owner’s additional services and expenses made necessary by such default, neglect or failure. If payments then or thereafter due the Contractor are not sufficient to cover such amounts, the Contractor will pay the difference to the Owner.

2.05 PERSONAL LIABILITY OF PUBLIC OFFICIALS

In carrying out any of the Contract provisions or in exercising any power or authority granted to it by this Contract, there will be no liability upon the Design Professional or Owner, its authorized representatives, or any officials of the Owner either personally or as an official of the Owner. It is understood that in such matters they act solely as agents and representatives of the Owner. Contractor agrees to waive any personal claims it may have against Design Professional, its authorized representative or any officials of the Owner including its Board members, officers, employees, agents and volunteers.

PART 3 – CONTRACTOR

3.01 DEFINITION

The Contractor is the person or entity identified as such in the Contract and is referred to throughout the Contract Documents as if singular in number. The term “Contractor” means the Contractor or the Contractor’s authorized representative.

3.02 REVIEW OF CONTRACT DOCUMENTS AND FIELD CONDITIONS BY CONTRACTOR

- A. Prior to starting the Work, and at frequent intervals during the process thereof, the Contractor will carefully study and compare the Contract Documents with each other and with the information furnished by the Owner pursuant to Paragraph 2.02 B and will at once report to the Owner, any error, inconsistency or omission the Contractor may discover. Any necessary change will be ordered as provided in Part 7, CHANGES IN THE WORK, subject to the requirements of Paragraph 1.02 and other provisions of the Contract Documents.
 - 1. If the Contractor proceeds with the Work without such notice to the Owner, having discovered such errors, inconsistencies or omissions, or if by reasonable study of the Contract Documents, the Contractor could have discovered such, the Contractor will bear all costs arising therefrom.
- B. The Contractor will take field measurements and verify field conditions and will carefully compare such field measurements and conditions and other information known to the Contractor with the Contract Documents before commencing activities. Errors, inconsistencies or omissions discovered will be reported to the Owner at once.
- C. The Contractor will perform the work in accordance with the Contract Documents and submittals approved pursuant to Paragraph 3.12.
- D. The Contractor will give the Owner timely notice of all additional Drawings, Specifications, or instructions required to define the Work in greater detail, or to permit the progress of the Work.
- E. The Contractor will not proceed with any Work not clearly and consistently defined in detail in the Contract Documents, but will request additional Drawings or instructions from the Owner as provided in Subparagraph 3.02 D. If the Contractor proceeds with such Work without obtaining further Drawings, Specifications or instructions, the Contractor will correct Work incorrectly done at the Contractor's own expense.

3.03 SUPERVISION AND CONSTRUCTION PROCEDURES

- A. The Contractor will supervise and direct the Work, using the Contractor's best skill and attention. The Contractor will be solely responsible for and have control over construction means, methods, techniques, sequences and procedures and for coordinating all portions of the Work under the Contract.
- B. The Contractor will be responsible to the Owner for the acts and omissions of all entities or persons performing or supplying the Work under the Contract.
- C. The Contractor will not be relieved of obligations for performing the Work in accordance with the Contract Documents either by activities or duties of the Owner in the administration of the Contract, or by tests, inspections or approvals required or performed by persons other than the Contractor.
- D. The Contractor will be responsible for inspection of portions of Work already performed under the Contract to determine that such portions are in proper condition to receive subsequent work.

- E. All Work by the Contractor will be performed in a workmanlike manner, satisfactory to the Owner. The Contractor will provide adequate supervision and inspections to assure competent performance of the Work.

3.04 LABOR AND MATERIALS

- A. Unless otherwise provided in the Contract Documents, the Contractor will provide and pay for labor, materials, equipment, tools, construction equipment and machinery, water, heat utilities, transportation, and other facilities and services necessary for proper execution and completion of the Work, whether temporary or permanent and whether or not incorporated or to be incorporated in the Work. The word "provide" will mean furnish and install complete, including connections, unless otherwise specified.
- B. The Contractor will enforce strict discipline and good order among the Contractor's employees and other persons carrying out the Contract. The Contractor will not permit employment of unfit persons or persons not skilled in tasks assigned to them.

3.05 WARRANTY

- A. The warranty provided in this Paragraph 3.05 will be in addition to and not in limitation of any other warranty provided by the Contract Documents or otherwise prescribed by Law.
- B. All defective Work or Work found not to be in compliance with the requirements of the Contract, or applicable law, building codes, rules or regulations, appearing within one year of the date of Substantial Completion of the whole Work will be promptly corrected by the Contractor at the Contractor's own cost.
- C. The Contractor warrants that the materials and equipment furnished under the Contract will be new and of recent manufacture unless otherwise specified, and that all work will be of good quality, free from faults and defects, and in conformance with the Contract Documents. Work not conforming to these requirements, including substitutions not properly approved and authorized, may be considered defective.
- D. The Contractor will be responsible for determining that all materials furnished for the Work meet all requirements of the Contract Documents. The Owner may require the Contractor to produce reasonable evidence that a material meets such requirements, such as certified reports of past tests by qualified testing laboratories, report of studies by qualified experts, or other evidence which in the opinion of the Owner would lead to a reasonable certainty that any material used, or proposed to be used, in the Work meets the requirements of the Contract Documents.
 - 1. All such data will be furnished at the Contractor's expense. This provision will not require the Contractor to pay for periodic testing of different batches of the same material, unless such testing is specifically required by the Contract Documents to be performed at the Contractor's expense.
- E. In all cases in which a manufacturer's name, trade name or other proprietary designation is used in connection with materials or articles to be furnished under this Contract, whether or not the phrase "or equal" is used after such name, the Contractor will furnish the product of the named manufacturer(s) without substitution, unless a written request for a substitution has been submitted by the Contractor and approved

by the Design Professional as provided in Subparagraph 3.05 D. Refer to Section 01605 – PRODUCTS AND SUBSTITUTIONS for additional requirements.

- F. If the Contractor proposes to use a material which, while suitable for the intended use, deviates in any way from the detailed requirements of the Contract Documents, the Contractor will inform the Owner in writing of the nature of such deviation at the time the material is submitted for approval and will request written approval of the deviation from the requirements of the Contract Documents.
- G. In requesting approval of deviations or substitutions, the Contractor will provide, upon request, evidence leading to a reasonable certainty that the proposed substitution or deviation will provide a quality or result at least equal to that otherwise attainable. If, in the opinion of the Owner, the evidence presented by the Contractor does not provide a sufficient basis for such reasonable certainty, the Owner may eject such substitution or deviation without further investigation.
- H. The Contract Documents are intended to produce a structure of consistent character and quality of design. All components of the structure including visible items of mechanical and electrical equipment have been selected to have a coordinated design in relation to the overall appearance and function of the Project. The Design Professional or Owner will judge the design and appearance of proposed substitutes on the basis of their suitability in relation to the overall design of the Project, as well as for their intrinsic merits. The Design Professional or Owner will not approve as equal to the materials specified, proposed substitutes which, in the Design Professional's or Owner's opinion, would be out of character, obtrusive, or otherwise inconsistent with the character or quality of design of the Project. In order to permit coordinated design of color and finishes, the Contractor will, if required by the Design Professional or Owner, furnish the substituted material in any color, finish, texture, or pattern which would have been available from the manufacturer originally specified, at no additional cost to the Owner.
- I. Any additional cost, or any loss or damage arising from the substitution of any material or any method from those originally specified, will be borne by the Contractor, notwithstanding approval or acceptance of such substitution by the Owner or the Design Professional, unless such substitution was made at the written request or direction of the Owner or the Design Professional.
- J. The Contractor will procure and deliver to the Owner, prior to Final Payment, all special warranties required by the Contract Documents. Delivery by the Contractor will constitute the Contractor's guarantee to the Owner that the warranty will be performed in accordance with its terms and conditions. Refer to Sections 01700 – PROJECT CLOSEOUT and 01740 – WARRANTIES for additional requirements.
- K. The warranties set out herein are not in lieu of any other warranties, express or implied, including any implied warranty of merchantability or fitness for a particular purpose. The warranties set out herein are not in lieu of any other contractual, legal or equitable remedies available to the Owner. If the Contractor fails to correct any defective Work or Work found not to be in compliance with the requirements of the Contract Documents, or applicable laws, building codes, rules or regulations, within a reasonable time after receipt of written notice from the Owner, the Owner may correct it in accordance with Owner's right to carry out the Work. If such case occurs prior to final payment, an appropriate Change Order shall be issued deducting the cost of correcting such

deficiencies from payments then or thereafter due to the Contractor. If payments then or thereafter due Contractor are not sufficient, the Contractor shall pay the difference to the Owner. All claims, costs, losses, and damages arising out of or relating to such correction or repair or such removal and replacement (including but not limited to all costs of repair or replacement of work by others) will be paid by Contractor.

- L. If the Contractor's correction or removal of defective Work causes damage to or destroys other completed or partially completed construction, the Contractor shall be responsible for the cost of correcting the destroyed or damaged construction.
- M. Nothing contained in Article 3.05 shall be construed to establish a period of limitations with respect to other obligations the Contractor has under this Contract. Establishment of the one-year period for correction of Work as described in this Article relates only to the specific obligation of the Contractor to correct the Work, and has no relationship to the time within which the obligation to comply with the Contract may be sought to be enforced, nor to the time within which proceedings may be commenced to establish the Contractor's liability with respect to the Contractor's obligations other than to specifically correct the Work.
- N. If after the one year correction period, but before the applicable limitations period, the Owner discovers any defective Work or Work found not to be in compliance with the requirements of the Contract Documents, or applicable laws, building codes, rules or regulations, the Owner shall, unless the defective Work or Work found not to be in compliance with the requirements of the Contract Documents, or applicable laws, building codes, rules or regulations requires emergency correction, notify the Contractor. If the Contractor elects to correct the Work, it shall provide written notice of such intent within fourteen (14) days of its receipt of notice from the Owner. The Contractor shall complete the correction of Work within a mutually agreed time frame. If the Contractor does not elect to correct the Work, the Owner may correct the Work by itself or others and charge the Contractor for the reasonable costs of the correction. Owner shall provide Contractor an accounting of such correction costs incurred.
- O. Contractor's obligation to perform and complete the Work in accordance with the Contract Documents shall be absolute. None of the following will constitute an acceptance of the Work that is not in accordance with the Contract Documents or release the Contractor's obligation to perform the Work in accordance with the Contract Documents: (1) observations by the Owner or the Owner's agents; (2) recommendations for payment made to the Owner or payment by the Owner (whether progress or final); (3) issuance of Certificates of Substantial or Final Completion; (4) use or occupancy of the Work or any part thereof by the Owner; (5) any review and approval of a Shop Drawing or sample submittal; (6) any inspection, test or approval by others; or (7) any correction of defective Work by the Owner.

3.06 TAXES

- A. The Contractor will pay sales, consumer, use and similar taxes for the Work or portions thereof provided by the Contractor which are legally enacted when Bids are received or negotiations concluded, whether or not yet effective or merely scheduled to go into effect.
- B. Pursuant to Sales and Use Tax Law, Chapter 212, Florida Statutes, the Hillsborough County Aviation Authority is exempt from the payment of sales tax. The Hillsborough

County Aviation Authority Certificate Number is 85-8013883484C-4. Unless otherwise indicated in the Contract Documents, all goods and services performed by Subcontractor (Sub-Subcontractors) or by suppliers are not exempt from State Sales Tax. All work performed by subcontractors for the Contractor and all supplies provided to the Subcontractor or Contractor are not exempt from State Sales Tax. All questions regarding the State of Florida Sales and Use Tax Law should be referred to the State of Florida Department of Revenue, Tallahassee, Florida.

3.07 PERMITS, FEES AND NOTICES

- A. The Contractor will secure and pay for all necessary and required permits and licenses including, but not limited to, batch plant permit(s), building permit(s), and all other permits, as well as all other fees, charges, taxes, licenses and inspections necessary for proper execution of the Contract and which are legally required when Bids are received. The Contractor will secure and pay for all Certificates of Inspection and of Occupancy that may be required by authorities having jurisdiction over Work. No extension of time for completion will be granted. All appropriate sites, building and electrical permits, etc. shall be obtained and paid for by the Contractor. In addition, jurisdiction over this Work, and all required Certificates of Inspection and Occupancy, will be obtained from the appropriate jurisdiction as listed below:

Tampa International Airport (TPA)	Hillsborough County Board of County Commissioners (BOCC) and/or City of Tampa
Peter O. Knight Airport (POK)	City of Tampa
Plant City Airport (PCA)	City of Plant City
Tampa Executive Airport (TEA)	BOCC

- B. The Contractor will fully comply with all applicable federal, state, county, municipal or other governmental laws, executive orders, wage, hour and labor, equal employment opportunity, disadvantaged business enterprises, pollution control, and environmental regulations, applicable national and local codes, Owner Rules and Regulations, and the Contractor will obtain all necessary permits, pay all required fees and taxes, and otherwise perform these services in a legal manner. To the maximum extent permitted by law, the Contractor will indemnify and hold Owner harmless from any fees, damages, fines or costs of any kind arising out of Contractor’s failure to comply with such governmental regulations. This obligation to indemnify and hold harmless will be construed separately and independently. It is the parties mutual intent that if this change is found to be in conflict of the law, the clause will be considered modified by such law to the extent necessary to remedy the conflict. The Contractor will give all notices necessary and incidental to the due and lawful prosecution of the Work so as not to delay the completion of the Work.
- C. If the Contractor observes that portions of the Contract Documents are at variance with applicable laws, statutes, ordinances, building codes, and rules and regulations, the Contractor will promptly notify the Owner in writing, and necessary changes will be accomplished by appropriate Modification.
- D. If the Contractor performs Work that it knew or should have known to be contrary to laws, statutes, ordinances, building codes, and rules and regulations without such notice

to the Owner and Design Professional, the Contractor will assume full responsibility for such Work and will bear the attributable costs.

- E. The Contractor will keep fully informed of all Federal and State Laws, all local laws, ordinances, and regulations and all orders and decrees of bodies or tribunals having any jurisdiction or authority, which in any manner affect those engaged or employed on the Work, or which in any way affect the conduct of the Work. To the maximum extent permitted by law, the Contractor will at all times observe and comply with all such laws, ordinances, regulations, orders and decrees.

3.08 ALLOWANCES

- A. The Contractor will include in the Contract Sum all allowances stated in the Contract Documents. Items covered by allowances will be supplied for such amounts and by such persons or entities as the Owner may direct, but the Contractor will not be required to employ persons or entities against which the Contractor makes reasonable objection.
- B. Unless otherwise provided in the Contract Documents:
 - 1. Allowances will cover the cost to the Contractor of materials and equipment delivered at the site and all required taxes, less applicable trade discounts;
 - 2. Contractor's costs for unloading and handling at the site, labor, installation costs, overhead, profit and other expenses contemplated for stated allowance amounts will be included in the allowances;
 - 3. Whenever costs are more than or less than allowances, the Contract Sum will be adjusted accordingly by Change Order. The amount of the Change Order will reflect (1) the difference between actual costs and the allowances under Subparagraph 3.08 B.1. and (2) changes in Contractor's costs under Subparagraph 3.08 B.2.

3.09 CONTRACTOR'S MANAGEMENT TEAM

- A. The Contractor will employ a competent, full-time Project Management Team (Team) reasonably acceptable to the Owner and the Design Professional, consisting of at least one Field Supervisor and necessary representatives who will be in attendance at the Project site full time during the progress of the Work until the date of Substantial Completion of the whole Work, or for such additional time thereafter as the Owner may determine to be necessary for the expeditious completion of the Work.
 - 1. The names and qualifications of this Team for this Work will be submitted as part of the Bidder's Qualification Form. They will have a minimum of five years of experience on similar projects of equal difficulty.
 - 2. The Owner will not recognize any subcontractor on the Work. The Contractor will at all times when Work is in progress be represented either in person by a qualified superintendent, or by other designated, qualified representative who is duly authorized to receive and execute orders of the Owner or the Design Professional.
 - 3. The Team will each have full authority to act on the Contractor's behalf. It is agreed and understood that, if requested in writing by the Owner or the Design

Professional, the Contractor will replace any member of the Team with another individual meeting the required qualifications within three days of the receipt of the request if the Team member is found to be unsatisfactory to the Owner or the Design Professional for whatever reason. The Team will represent the Contractor and communications given to the Team will be as binding as if given to the Contractor. Important communications will be similarly confirmed on written request for each case. Should the Owner or the Design Professional find any person(s) employed on the Project to be incompetent, unfit, or otherwise objectionable for its duties, the Contractor will immediately cause the employee to be dismissed and said employee will not be re-employed on this Project without written consent of the Owner or the Design Professional.

3.10 CONTRACTOR'S CONSTRUCTION SCHEDULES

- A. The Contractor will submit preliminary and CPM (or bar chart) construction schedules in accordance with requirements under Section 01315 – SCHEDULES, PHASING. The schedule will not exceed time limits current under the Contract Documents. The schedule will be revised at appropriate intervals as required by the conditions of the Work and Project, will be related to the entire Project to the extent required by the Contract Documents, and will provide for expeditious and practicable execution of the Work.
- B. The Contractor will prepare and keep current, for the Design Professional's and Owner's approval, a schedule of submittals which is coordinated with the Contractor's construction schedule and allows the Design Professional and Owner reasonable time to review submittals.
- C. The Contractor's performance will conform to the most recent schedules.

3.11 DOCUMENTS AND SAMPLES AT THE SITE

The Contractor will maintain at the site for the Owner one as-built set of the Drawings, Specifications, addenda, Change Orders and other Modifications, in good order and marked currently to record changes and selections made during construction, as well as approved Shop Drawings, Product Data, Samples and similar required submittals. These will be available to the Owner and Design Professional and will be delivered to the Design Professional for submittal to the Owner upon completion of the work. As-Built drawings will be reviewed monthly as part of the pay application process.

3.12 SHOP DRAWINGS, PRODUCT DATA AND SAMPLES

- A. Shop Drawings are drawings, diagrams, schedules, models and other data (including electronic data) specifically prepared for the work by the Contractor or a Subcontractor, Sub-Subcontractor, manufacturer, supplier or distributor to illustrate some portion of the Work.
- B. Product data are illustrations, standard schedules, performance charts, instructions, brochures, diagrams and other information furnished by the Contractor to illustrate materials or equipment for some portion of the Work.
- C. Samples are physical examples which illustrate materials, equipment or workmanship and established standards by which the Work will be judged.

- D. Shop Drawings, Product Data, Samples and similar submittals are not Contract Documents. The purpose of their submittal is to demonstrate for those portions of the Work for which submittals are required the way the Contractor proposes to conform to the information given and the design concept expressed in the Contract Documents. Review by the Design Professional or Owner is subject to the limitations of Subparagraph 4.02 G.
- E. The Contractor will review, approve and submit to the Design Professional Shop Drawings, Product Data, Samples and similar submittals required by the Contract Documents with reasonable promptness and in such sequence as to cause no delay in the Work or in the activities of the Owner or of separate contractors. Submittals made by the Contractor which are not required by the Contract Documents may be returned without action.
- F. The Contractor will perform no portion of the Work requiring submittal and review of Shop Drawings, Product Data, Samples or similar submittals until the respective submittal has been approved by the Design Professional. Such work will be in accordance with approved submittals.
- G. By approving and submitting Shop Drawings, Product Data, Samples, and similar submittals, the Contractor thereby represents that the Contractor has determined and verified all dimensions, qualities, field dimensions, relations to existing work, coordination with work to be installed later, coordination with information on previously accepted Shop Drawings, Product Data, Samples, or similar submittals and verification of compliance with all the requirements of the Contract Documents. The accuracy of such information is the responsibility of the Contractor. In reviewing Shop Drawings, Product Data, Samples, and similar submittals, the Owner will be entitled to rely upon the Contractor's representation that such information is correct and accurate.
- H. The Contractor will not be relieved of responsibility for deviations from requirements of the Contract Documents by the Owner's approval of Shop Drawings, Product Data, Samples or similar submittals unless the Contractor has specifically informed the Owner in writing of such deviation at the time of submittal and the Owner has given written approval to the specific deviation. The Contractor will not be relieved of responsibility for errors or omissions in Shop Drawings, Product Data, Samples or similar submittals by the Owner's approval thereof.
- I. The Contractor will direct specific attention, in writing or on resubmitted Shop Drawings, Product Data, Samples or similar submittals, to revisions other than those requested by the Design Professional or Owner on previous submittals. Unless such written notice has been given, the Design Professional's or Owner's approval of a resubmitted Shop Drawing, Product Data, Sample, or similar submittal will not constitute approval of any changes not requested on the prior submittal.
- J. Informational submittals upon which the Owner is not expected to take responsive action may be so identified in the Contract Documents.
- K. When professional certification of performance criteria of materials, systems or equipment is required by the Contract Documents, the Design Professional or Owner will be entitled to rely upon such certifications, and the Design Professional or Owner will not be required to make any independent examination with respect thereto.

- L. The Contractor will keep one clean copy of each submittal brochure and each Shop Drawing, bearing the Design Professional's or Owner's review stamp, at the Job Site.
- M. The Design Professional's or Owner's review is only for conformance with the design concept of the Project and compliance with the information given in the Contract Documents. The Contractor is responsible for dimensions to be confirmed and correlated at the Job Site, for information processes or techniques of construction, and for coordination of the Work of all trades.
- N. Burden-of-proof that products, materials, Shop Drawings, samples and submittals comply with the Contract Documents in every respect and that any substitutions, variations, deviations or modifications do exactly what is specified and will, in fact, work well in coordination and harmony and will serve the intended purpose will rest entirely with the Contractor. It will not be the Design Professional's or Owner's responsibility to have the burden-of-proof to prove the contrary.
- O. Submittals, requisitions, requests for interpretation, Shop Drawings and other items received by the Design Professional or Owner on Friday, Saturday, Sunday, on any normally recognized holiday, or on a day preceding such a holiday, will be considered received on the first working day (except Friday) which follows.
- P. Owner's date stamp of receipt will evidence date of receipt, modified per Paragraph 3.12 O. above. Date indicated on Owner's transmittal letter or transmittal form will be considered as date returned to Contractor.
- Q. Refer to Section 01340 – SHOP DRAWINGS, PRODUCT DATA AND SAMPLES for additional requirements.

3.13 USE OF SITE

- A. The right of possession of the premises and the improvements made thereon by the Contractor will remain at all times with the Owner. The Contractor's right to entry and use thereof arises solely from the permission granted by the Owner under the Contract Documents.
 - 1. The Contractor will confine the Contractor's apparatus, the storage of materials and the operations of the Contractor's personnel to limits indicated by law, ordinances, the Contract Documents and permits and/or directions of the Design Professional and will not unreasonably encumber the premises with the Contractor's materials. The Owner will not be liable to the Contractor, the Subcontractors, their employees or anyone else with respect to the conditions of the premises.
 - 2. Material will be arranged and maintained in an orderly manner with use of walks, drives, roads and entrances unencumbered. Store, place and handle material and equipment delivered to the Project Site so as to preclude inclusion of foreign substances or causing of discoloration. Pile neatly and compactly and barricade to protect public from injury. Protect material as required to prevent damage from weather or ground. Should it be necessary to move material at any time, or move sheds or storage platforms, the Contractor will move them as and when required at no additional cost to the Owner.

3. The Owner assumes no responsibility for materials stored in buildings or on the Project site. The Contractor will assume full responsibility for damage due to storing of materials. Repairing of areas used for placing of sheds, offices and storage of materials will be performed by the Contractor.

3.14 CUTTING AND PATCHING

- A. The Contractor will be responsible for cutting, fitting or patching required to complete the Work or to make its parts fit together properly.
- B. The Contractor will not damage or endanger a portion of the Work or fully or partially completed construction of the Owner or separate contractors by cutting, patching or otherwise altering such construction, or by excavation. The Contractor will not cut or otherwise alter such construction by the Owner or a separate contractor except with written consent of the Owner and of such separate contractor; such consent will not be unreasonably withheld. The Contractor will not unreasonably withhold from the Owner or a separate contractor the Contractor's consent to cutting or otherwise altering the Work.
- C. Refer to Section 01045 – CUTTING AND PATCHING for additional requirements.

3.15 CLEAN UP

- A. The Contractor will keep the premises and surrounding area free from accumulation of waste materials or rubbish caused by operations under the Contract. At completion of the Work, the Contractor will remove from and about the Project waste materials, rubbish, the Contractor's tools, construction equipment, machinery and surplus materials.
- B. If the Contractor fails to clean up as provided in the Contract Documents, the Owner may do so and the cost thereof will be charged to the Contractor.
- C. Daily Clean-Up: The Contractor will keep the premises free from accumulation of waste materials or rubbish caused by Contractor's operations on a daily basis. In areas used by the public or exposed to public view, the Contractor will keep these areas in such a state of cleanliness so as not to reflect unfavorably upon the "image" of the Owner or any airport authority concerned. In areas near airport operations, the Contractor will keep areas free from materials which could possibly be ingested into an aircraft engine or which could cause damage by being blown by aircraft engine blast effects.
- D. Refer to Sections 01110 – AIRPORT PROJECT PROCEDURES and 01700 – PROJECT CLOSEOUT for additional requirements.

3.16 ACCESS TO WORK

The Contractor will provide the Owner and Design Professional access to the Work in preparation and progress wherever located.

3.17 ROYALTIES AND PATENTS

The Contractor will pay all royalties and license fees. The Contractor will defend suits or claims for infringement of patent rights and will hold the Owner and Design Professional harmless from loss on account thereof, but will not be responsible for such defense or loss when a particular design, process or

product of a particular manufacturer or manufacturers is required by the Contract Documents. However, if the Contractor has reason to believe that the required design, process or product is an infringement of a patent; the Contractor will be responsible for such loss unless such information is promptly furnished to the Owner.

3.18 THIRD PARTY BENEFICIARY CLAUSE.

It is specifically agreed between the parties executing the Contract that the provisions of any part of the Contract do not create in the public or any member thereof any rights as a third party beneficiary nor do the provisions of any part of the Contract authorize anyone not a party to the Contract to maintain a suit for personal injuries or property damage pursuant to the provisions of the Contract.

3.19 RECORDS AND DOCUMENTS

The Contractor will maintain all records and documents relating to the Contract during the course of the Work and for a period of seven years after the date of Final Acceptance. This includes all books and other evidence (including but not limited to subcontracts, subcontract change orders, purchase orders, bid tabulations, proposals, and other documents associated with the Contract) bearing on the Contractor's costs and expenses under this Contract. The Contractor will make these records and documents available for inspection by the Owner at the Contractor's office at all reasonable times, without direct charge, and will provide electronic copies of all requested documents including but not limited to subcontracts, subcontract change orders, purchase orders, bid tabulations, proposals, and all other documents associated with the project at no cost to the Owner. If approved by the Owner, photographs, microphotographs, or other authentic reproductions may be maintained instead of original records and documents. If the Contractor fails to make the records and documents available, the Owner may, after written notice to the Contractor, take such action as may be necessary including the withholding of any further payment. Furthermore, failure to make such records and documents available may be grounds for termination pursuant to Paragraph 13.01 or grounds for Owner to seek damages from Contractor.

PART 4 – ADMINISTRATION OF THE CONTRACT

4.01 Design Professional

- A. The Design Professional is referred to throughout the Contract Documents as if singular.
 - 1. Wherever the term "Design Professional" appears in the Contract Documents, it will mean the Design Professional on record for the project or Owner's other authorized representative(s).
 - 2. Wherever the term "Owner's authorized representative(s)" appears in the Contract Documents, it will include Owner, or Owner's other authorized representative(s).
- B. In case of termination of employment of the Design Professional, the Owner will appoint a Design Professional against whom the Contractor makes no reasonable objection and whose status under the Contract Documents will be that of the former Design Professional.

4.02 DESIGN PROFESSIONAL'S ADMINISTRATION OF THE CONTRACT

- A. The Design Professional will provide administration of the Contract as described in the Contract Documents, and will be the Owner's representative (1) during construction,

(2) until final payment is due and (3) with the Owner's concurrence, from time to time during the correction period described in Paragraph 11.02. The Design Professional will advise and consult with the Owner. The Design Professional will have authority to act on behalf of the Owner.

- B. The Design Professional will visit the site at intervals appropriate to the stage of construction to become generally familiar with the progress and quality of the completed Work and to determine in general if the Work is being performed in a manner indicating that the Work, when completed, will be in accordance with the Contract Documents. However, the Design Professional will not be required to make exhaustive or continuous on-site inspections to check quality or quantity of the Work. On the basis of on-site observations, the Design Professional will keep the Owner informed of the progress of the Work and will endeavor to guard the Owner against defects and deficiencies in the Work.
- C. The Design Professional will not have control over or charge of, and will not be responsible for, construction means, methods, techniques, sequences or procedures, or for safety precautions and programs in connection with the Work, since these are solely the Contractor's responsibility as provided in Paragraph 3.03. The Design Professional will not be responsible for the Contractor's failure to carry out the Work in accordance with the Contract Documents. The Design Professional will not have control over or charge of, and will not be responsible for, acts or omissions of the Contractor, Subcontractors, or their agents or employees, or of any other persons performing portions of the Work.
- D. Communications Facilitating Contract Administration. Except as otherwise provided in the Contract Documents or when direct communications have been specially authorized, the Owner and Contractor will endeavor to communicate through the Design Professional. Communications by and with the Design Professional's consultants will be through the Design Professional. Communications by and with subcontractors and material suppliers will be through the Contractor. Communications by and with separate contractors will be through the Owner.
- E. Based on the Design Professional's observations and evaluations of the Contractor's Applications for Payment, the Design Professional will review and certify the amounts due the Contractor and will approve or disapprove the Application for Payment.
- F. The Owner and Design Professional will have authority to reject Work which does not conform to the Contract Documents. Whenever the Owner or Design Professional considers it necessary or advisable for implementation of the intent of the Contract Documents, the Owner or Design Professional will have authority to require additional inspection or testing of the Work in accordance with Subparagraphs 12.05 B. and 12.05 C., whether or not such work is fabricated, installed or completed. However, neither this authority of the Owner or Design Professional nor a decision made in good faith either to exercise or not to exercise such authority will give rise to a duty or responsibility of the Owner or Design Professional to the Contractor, subcontractors, material and equipment suppliers, their agents or employees, or other persons performing portions of the Work.
- G. The Design Professional will review and approve or take other appropriate action upon the Contractor's submittals such as Shop Drawings, Product Data and Samples, but only for the limited purpose of checking for conformance with information given and the

design concept expressed in the Contract Documents and only to the extent which the Owner or Design Professional believes desirable to protect the Owner's interests. The Design Professional's action will be taken with reasonable promptness, while allowing sufficient time in the Design Professional's professional judgment to permit adequate review, taking into account the time periods set forth in the latest recognized Construction Schedule prepared by the Contractor and reviewed by the Design Professional. Review of such submittals is not conducted for the purpose of determining the accuracy and completeness of other details such as dimensions and quantities, or for substantiating instructions for installation or performance of equipment or systems, all of which remain the responsibility of the Contractor as required by the Contract Documents. The Design Professional's review of the Contractor's submittals will not relieve the Contractor of the obligations under Paragraphs 3.03, 3.05 and 3.12. The Design Professional's review will not constitute approval of safety precautions or of any construction means, methods, techniques, sequences or procedures. The Design Professional's approval of a specific item will not indicate approval of an assembly of which the item is a component.

- H. The Design Professional or Owner will prepare Change Orders and Construction Change Directives, and may authorize minor changes in the Work as provided in Paragraph 7.04.
- I. The Design Professional will conduct inspections in conjunction with the Owner to determine the date or dates of Substantial Completion and the date of Final Acceptance, will receive and forward to the Owner for the Owner's review and records written warranties and related documents required by the Contract and assembled by the Contractor, and will review and certify a final Application for Payment upon compliance with the requirements of the Contract Documents.
- J. The Design Professional, in conjunction with the Owner, will interpret and decide matters concerning performance under and requirements of the Contract Documents on written request of the Contractor. The Design Professional's response to such requests will be made with reasonable promptness and within time limits agreed upon. The Design Professional may, as the Design Professional judges desirable, issue additional drawings or instructions indicating in greater detail the construction or design of the various parts of the Work. Such drawings or instructions may be affected by other supplemental instruction or other notice to the Contractor and, provided such drawings or instructions are reasonably consistent with the previously existing Contract Documents, the Work will be executed in accordance with such additional drawings or instructions without additional cost or extension of the Contract Time.
- K. Interpretations and decisions of the Design Professional, in conjunction with the Owner, will be consistent with the intent of and reasonably inferable from the Contract Documents and will be in writing or in the form of drawings. When making such interpretations and decisions, the Design Professional will endeavor to secure faithful performance by both Owner and Contractor, will not show partiality to either and will not be liable for results of interpretations or decisions so rendered in good faith.
- L. The Design Professional's decisions on matters relating to aesthetic effect will be final if consistent with the intent expressed in the Contract Documents.

4.03 CLAIMS AND DISPUTES

- A. Definition. A Claim is a written demand or assertion by one of the parties seeking, as a matter of right, adjustment or interpretation of Contract terms, payment of money, or an extension of time or other relief with respect to the terms of the Contract. The term "Claim" also includes other disputes and matters in question between the Owner and Contractor arising out of or relating to the Contract. Claims must be made by written notice. The responsibility to substantiate claims will rest with the party making the claim.
1. If for any reason the Contractor deems that additional cost or Contract Time is due to the Contractor for Work not clearly provided for in the Contract Documents or previously authorized changes in the Work, the Contractor will notify the Owner in writing of its intention to claim such additional cost or Contract Time before the Contractor begins the Work on which the Contractor bases the claim. If such notification is not given or the Owner is not afforded proper opportunity by the Contractor for keeping strict account of actual cost or time as required, then the Contractor hereby agrees to waive any claim for such additional cost or Contract Time.
 2. Such notice by the Contractor and the fact that the Owner or Design Professional has kept account of the cost or time of the Work will not in any way be construed as proving or substantiating the validity of the Claim. When the Work on which the Claim for additional cost or Contract Time is based has been completed, the Contractor will, within 21 calendar days, submit Contractor's written Claim to the Owner. The failure to give notice as required herein will constitute a waiver of said Claim. Claims arising prior to Final Payment or the earlier termination of the Contract will be referred initially to the Owner for action as provided in Paragraph 4.04.
- B. Claims must be made within 21 calendar days after occurrence of the event giving rise to such Claim or within 21 calendar days after the claimant first recognizes the condition giving rise to the Claim, whichever is later. If the Contractor wishes to reserve its rights under this Paragraph, written notice of any event that may give rise to a Claim must be given within 21 calendar days of the event, whether or not any impact in money or time has been determined. Claims must be made by written notice. Any change or addition to a previously made Claim will be made by timely written notice in accordance with this Paragraph. The failure to give notice as required herein will constitute a waiver of said Claim.
- C. Continuing Contract Performance. Pending final resolution of a Claim, unless otherwise agreed in writing, the Contractor will proceed diligently with performance of the Contract. Owner, however, will be under no obligation to make payments on or against such disputed claims, disputes or other matters in question during the pendency of any proceedings to resolve such disputed claims, disputes or other matters in question.
- D. Non-Waiver of Claims: Final Payment. The making of final payment will not constitute a waiver of claims by the Owner.
- E. Claims For Concealed or Unknown Conditions. Owner may make available to the Contractor prior to the bid opening and during the performance of the Work, Record Documents and Drawings pertaining to the existing structures and/or facilities relative to this Project. Record Documents and Drawings will not be considered a part of the Contract Documents. Owner does not warrant the accuracy of such Record Documents

and Drawings to the Contractor and the Contractor will be solely responsible for all assumptions made in reliance thereupon. Record Documents and Drawings are not warranted or intended to be complete depictions of existing conditions, nor do they necessarily indicate concealed conditions. The locations of electrical conduit, telephone lines and conduit, computer cables, FAA cables, storm lines, sanitary lines, irrigation lines, gas lines, mechanical apparatus and appurtenances, HVAC piping/ductwork, and plumbing may only appear schematically, if at all, and the actual location of such equipment is in many cases unknown. Contractor will take the foregoing into consideration when preparing its bid, and will not be entitled to any additional compensation on account of concealed conditions except as specifically set forth below.

1. Should the Contractor encounter concealed conditions in an existing structure or below the surface of the ground, not discoverable by a careful inspection and differing materially from conditions ordinarily encountered and generally recognized in or about a site of this type, the Contractor will stop work at the location where the concealed condition was discovered and give immediate written notice of the condition to the Owner. The Owner and Design Professional shall investigate and adjust the Contract Sum and/or time by Change Order upon claim by either party, if made before conditions are disturbed and in no event later than 21 days after the first observance of the conditions. Nothing herein is intended to limit or modify the obligations of the Contractor set forth in Section 01545 – UTILITIES. Contractor shall not be entitled to a Change Order for the Contract Sum and/or time if the Contractor knew of the existence of such conditions at the time Contractor bid, or the existence of such conditions could have been reasonably discovered or revealed as a result of any examination, investigation, exploration, test, or study of the site and contiguous areas as required by the Contract, or if Contractor failed to give written notice as required by this Article.
 2. There will be no adjustment of the Contract Sum on account of other costs resulting from topsoil or water conditions including, without limitation, costs on account of delay, administration, operations, temporary construction, cave-in or collapse of excavations, or pumping.
- F. Claims for additional cost. If the Contractor wishes to make claim for an increase in the Contract Sum, written notice as provided herein will be given before proceeding to execute the Work. Prior notice is not required for Claims relating to an emergency endangering life or property arising under paragraph 10.03. Claim will be filed in accordance with the procedure established herein. Anticipated, unanticipated, abnormal or adverse weather conditions will not be the basis of a claim for additional cost. The Contract Sum will not be increased for any weather related conditions.
- G. CLAIMS FOR ADDITIONAL TIME.
1. If the Contractor wishes to make claim for an increase in the Contract Time, written notice as provided herein will be given. The Contractor will have the burden of demonstrating the effect of the claimed delay on the Contract Time, and will furnish the Owner with such documentation relating thereto as the Owner will reasonably require. In the case of a continuing delay only one claim is necessary.

2. The Contract Time will not be increased for any reasonably anticipated weather related delay. The Owner may consider adverse weather conditions not reasonably anticipated as a basis of a claim for additional time.

H. ESCROW OF BID DOCUMENTS.

1. The Contractor agrees that all documents relied upon in making or supporting their Bid will be retained in escrow prior to the date the Contract is awarded and preserved and updated during the course of the Work until Final Payment is made. The Owner will have the right to inspect any and all such Bid Documents and to verify that such Bid Documents are properly escrowed prior to the time of the Award of the Contract, or at any time thereafter during the course of the Work.
 - a. If any Claim is made pursuant to the Contract, the Contractor will provide for the Owner's review, at the Owner's request, all escrowed Bid Documents. If the Owner requests to review the escrowed Bid Documents and the Contractor fails to timely provide them or has failed to preserve them, no claim by the Contractor will be honored by the Owner.
 - b. If the Contractor contends that such Bid Documents are proprietary or otherwise confidential, the Contractor will so state as to any such documents, will provide them to the Owner as part of the Claim process, and will identify all such documents as exempted from disclosure under Florida Statute Chapter 119.
 - c. Said escrowed Bid Documents referred to in this Part will be subject to review in the event of any audit. The Owner may require that an appropriate audit be conducted. In the event the audit supports the Contractor's claim, the Owner will pay for the audit. In the event the audit does not support the Contractor's claim, the Contractor will pay for the audit.
 - d. The Contractor will provide all information and reports requested by the Owner, or any of their duly authorized representatives, or directives issued pursuant thereto, and will permit access, for the purpose of audit and examination to the Contractor's books, records, accounts, documents, papers or other sources of information and its facilities, as may be determined by the Owner to be pertinent to ascertain compliance with this Part. The Contractor will keep all Project accounts and records which fully disclose the amount of the Bid. The accounts and records will be kept in accordance with an accounting system that will facilitate an effective audit in accordance with the Single Audit Act of 1984.

4.04 RESOLUTION OF CLAIMS AND DISPUTES

- A. The failure of Owner to enforce at any time or for any period of time any one or more provisions of this Contract will not be construed to be and will not be a waiver of any

such provision or provisional or of its right thereafter to enforce each and every provision.

- B. The following shall occur as a condition precedent to the Owner's review of a claim unless waived in writing by the Owner:

Field Representatives' Meeting: Within five days (5) after a dispute occurs, the Contractor's senior project management personnel who have authority to resolve the dispute shall meet with the Design Professional and Owner's project representative who have authority to resolve the dispute, in a good faith attempt to resolve the dispute. If a party intends to be accompanied at a meeting by legal counsel, the other party shall be given at least three (3) working days' notice of such and also may be accompanied by legal counsel. All negotiations pursuant to this clause are confidential and shall be treated as compromise and settlement negotiations for purposes of rules of evidence.

Management Representatives' Meeting: If the Field Representatives' Meeting fails to resolve the dispute, a senior executive for the Contractor and for the Owner, neither of which have day to day Project management responsibilities, shall meet, within ten days (10) after a dispute occurs, in an attempt to resolve the dispute and any other identified disputes or any unresolved issues that may lead to dispute. The Owner may invite the Design Professional to this meeting. If a party intends to be accompanied at a meeting by legal counsel, the other party shall be given at least three (3) working days' notice of such and also may be accompanied by legal counsel. All negotiations pursuant to this clause are confidential and shall be treated as compromise and settlement negotiations for purposes of rules or evidence.

Following the Field Representatives' Meeting and the Management Representatives' Meeting, the Owner will review the Contractor's claims and may (1) request additional information from the Contractor which will be immediately provided to Owner, or (2) render a decision on all or part of the claim. The Owner will notify the Contractor in writing of the disposition of the claim within 21 days following the receipt of such claim or receipt of additional information requested.

1. If the Owner decides that the Work relating to such Claim should proceed regardless of the Owner's disposition of such Claim, the Owner will issue to the Contractor a written directive to proceed. The Contractor will proceed as instructed.

PART 5 – SUBCONTRACTORS

5.01 DEFINITIONS

- A. A Subcontractor is a person or entity who has a direct contract with the Contractor to perform a portion of the Work. The term "Subcontractor" is referred to throughout the Contract Documents as if singular in number and means a Subcontractor or an authorized representative of the Subcontractor. The term "Subcontractor" does not include a separate Contractor or subcontractors of a separate Contractor.
- B. A Sub-subcontractor is a person or entity who has a direct or indirect contract with a Subcontractor to perform a portion of the Work. The term "Sub-Subcontractor" is

referred to throughout the Contract Documents as if singular in number and means a Sub-Subcontractor or an authorized representative of the Sub-Subcontractor.

- C. The Owner or Design Professional will not recognize any Subcontractor on the Work. The Contractor will at all times, when Work is in progress, be represented either in person by a qualified superintendent, or by other designated, qualified representative who is duly authorized to receive and execute orders of the Owner or Design Professional.

5.02 AWARD OF SUBCONTRACTS AND OTHER CONTRACTS FOR PORTIONS OF THE WORK

- A. Unless otherwise stated in the Contract Documents or the bidding requirements, the Contractor, as soon as practicable after award of the Contract, will furnish in writing to the Owner, the names of persons or entities (including those who are to furnish materials or equipment fabricated to a special design) proposed for each principal portion of the Work. After due investigation, the Owner will promptly reply to the Contractor in writing stating whether or not the Owner has reasonable objection to any such proposed person or entity. Failure of the Owner to reply promptly will constitute notice of no reasonable objection.
- B. The Owner reserves the right to investigate the prequalification and qualifications and responsibility of proposed or actual Subcontractors, and to prohibit same from performing Work on the Project where such investigation, in the judgment of the Owner, reveals that such Subcontractors are unqualified and/or non-responsible. The Owner's criteria for such determination may include, without limitation: financial condition, experience, character of workers and equipment, and past performance. The Contractor will not contract with a proposed person or entity to which the Owner has made reasonable and timely objection. The Contractor will not be required to contract with anyone to whom the Contractor has made reasonable objection.
- C. If the Owner has reasonable objection to any such proposed person or entity, the Contractor will submit a substitute to whom the Owner have no reasonable objection.
- D. The Contractor will not change a Subcontractor, person or entity listed in Contractor's Subcontractors List without permission of the Owner.
- E. Owner reserves the right but does not assume the obligation to pay any and all subcontractors and suppliers directly if a dispute arises with the Contractor. Contractor agrees that any such payment would not be an interference with contractual relations.

5.03 SUBCONTRACTUAL RELATIONS

By appropriate contract, written where legally required for validity, the Contractor will require each Subcontractor, to the extent of the work to be performed by the Subcontractor, to be bound to the Contractor by terms of the Contract Documents, and to assume toward the Contractor all the obligations and responsibilities which the Contractor, by the Contract Documents, assumes toward the Owner and Design Professional. Each subcontract agreement will preserve and protect the rights of the Owner and Design Professional under the Contract Documents with respect to the work to be performed by the Subcontractor so that subcontracting thereof will not prejudice such rights, and will allow to the Subcontractor, unless specifically provided otherwise in the subcontract, the benefit of all rights, remedies and redress against the Contractor that the Contractor, by the Contract Documents, has against the Owner. Where appropriate, the Contractor will require each Subcontractor to enter into

similar contracts with Sub-Subcontractors. The Contractor will make available to each proposed Subcontractor, prior to the execution of the subcontract, copies of the Contract Documents to which the Subcontractor will be bound, and, upon written request of the Subcontractor, identify to the Subcontractor terms and conditions of the proposed subcontract which may be at variance with the Contract Documents. Subcontractors will similarly make copies of applicable portions of such documents available to their respective proposed Sub-Subcontractors. The Contractor will include a provision providing the Owner the same rights to audit at the subcontractor level in all of its subcontractor agreements executed to effect project completion.

PART 6 – CONSTRUCTION BY OWNER OR BY SEPARATE CONTRACTORS

6.01 OWNER’S RIGHT TO PERFORM CONSTRUCTION AND TO AWARD SEPARATE CONTRACTS

- A. The Owner reserves the right to perform construction or operations related to the Project with the Owner’s own forces, and to award separate contracts in connection with other portions of the Project or other construction or operations on the site under conditions of the Contract identical or substantially similar to these including those portions related to insurance and waiver of subrogation.
- B. When separate contracts are awarded for different portions of the Project or other construction or operations on the site, the term “Contractor” in the Contract Documents in each case will mean the Contractor who executes each separate Owner-Contractor contract.
- C. The Contractor, with the Owner’s assistance, will coordinate each separate contractor with the Work of the Contractor, who will cooperate with them. The Owner will provide for the coordination of the Owner’s own forces with the Work of the Contractor, who will cooperate with them. The Contractor will coordinate with other separate contractors and the Owner in reviewing their construction schedules. The Contractor will make any revisions to the construction schedule deemed necessary after a joint review and mutual agreement. The construction schedules will then constitute the schedules to be used by the Contractor, separate contractors and the Owner until subsequently revised.

6.02 MUTUAL RESPONSIBILITY

- A. The Contractor will afford the Owner and separate contractors reasonable opportunity for introduction and storage of their materials and equipment and performance of their activities and will connect and coordinate the contractors’ construction and operations with theirs as required by the Contract Documents.
- B. If any part of the Contractor’s Work depends, for proper execution or operation, upon the Work or any applicable portion thereof, of any other separate Contractor, the Owner will give the Contractor written notice of the date when the other contractor will have completed its construction or any applicable portion thereof and the Contractor will have 15 days from the date so specified within which to inspect the other contractor’s construction or any applicable portion thereof and to accept said construction or to reject in a written statement to the Owner reciting all discrepancies or defects which affect Contractor’s work and, therefore, must be remedied. Upon receipt of such statement, the Design Professional will see that necessary corrections are made and will notify the Contractor when such corrective work is to be complete.

The Contractor will have 15 days from the date so specified within which to inspect and report again, in order to determine that discrepancies or defects have been corrected.

1. Failure of the Contractor to inspect and report, as set forth above, will constitute an acceptance of the other contractor's construction or any applicable portion thereof as fit and proper to receive Contractor's Work, except as to latent defects which may develop in the separate contractor's construction or any applicable portion thereof after the execution of the Contractor's work.
 2. Upon completion of the other contractor's construction or any applicable portion thereof, the area will be turned over to the Contractor.
- C. Costs caused by delays or defective construction will be borne by the party responsible therefore.
- D. The Contractor will promptly remedy damage wrongfully caused by the Contractor to completed or partially completed construction or to property of the Owner or separate contractors as provided in Subparagraph 10.02 E.
- E. Should the Contractor cause damage to the work or property of any separate contractor on the Project, the Contractor will, upon due notice by the Owner, settle with such other contractor by contract if other contractor will so settle. If such separate contractor sues the Owner on account of any damage alleged to have been so sustained, the Owner will notify the Contractor who will defend such proceedings with the cooperation of the Owner and, if any judgment against the Owner arises therefrom, the Contractor will pay or satisfy same to the extent caused by the fault of the Contractor and will reimburse the Owner for all reasonable attorneys' fees and court costs which the Owner has incurred.
- F. The Owner and each separate contractor will have the same responsibilities for cutting and patching as are described for the Contractor in Paragraph 3.14.

6.03 OWNER'S RIGHT TO CLEAN UP

If a dispute arises among the Contractor, separate contractors and the Owner as to the responsibility under their respective contracts for maintaining the premises and surrounding area free from waste materials and rubbish as described in Paragraph 3.15, the Owner may clean up and allocate the cost among those responsible as the Owner, in its sole discretion, determines to be just.

PART 7 – CHANGES IN THE WORK

7.01 CHANGES

- A. Changes in the Work may be accomplished after execution of the Contract, and without invalidating the Contract, only by Change Order, Supplemental Agreement, Construction Change Directive or order for a minor change in the Work, subject to the limitations stated in this Part and elsewhere in the Contract Documents.
1. Any Claim for payment for changes in the Work that is not covered by written Change Order will be rejected by the Owner. The Contractor, by submitting the Bid, acknowledges and agrees that the Contractor will not be entitled to

payment for changes in the Work unless such Work is specifically authorized in writing by the Owner in advance. The terms of this Part may not be waived by the Owner unless such waiver is in writing and makes specific reference to this Part.

- B. A Change Order will be based upon contract among the Owner and Contractor. A Construction Change Directive requires a contract by the Owner and may or may not be agreed to by the Contractor. An order for a minor change in the Work may be issued by the Owner alone.
- C. Changes in the Work will be performed under applicable provisions of the Contract Documents, and the Contractor will proceed promptly, unless otherwise provided in the Change Order, Construction Change Directive or order for a minor change in the Work.
- D. If unit prices are stated in the Contract Documents or subsequently agreed upon, and if quantities originally contemplated are so changed in a proposed Change Order or Construction Change Directive that application of such unit prices to quantities of Work proposed will cause substantial unfairness to the Owner or Contractor, the applicable unit prices will be adjusted.
- E. ALTERATION OF WORK AND QUANTITIES.
 - 1. The Owner reserves and will have the right to make such alterations in the Work as may be necessary or desirable to complete the Work originally intended in an acceptable manner. Unless otherwise specified herein, the Owner will be and is hereby authorized to make such alterations in the Work as may increase or decrease the originally awarded Contract Work, provided that the aggregate of such alterations does not change the total Contract cost or the total cost of any major Contract item by more than 25% (total cost being based on the unit prices and estimated quantities in the awarded Contract). Alterations that do not exceed the 25% limitation will not invalidate the Contract nor release the Surety, and the Contractor agrees to accept payment for such alterations as if the altered Work had been a part of the original Contract. These alterations which are for Work within the general scope of the Contract will be covered by "Change Orders" issued by the Owner. Change Orders for altered Work may include extensions of Contract Time where, in the Design Professional's opinion, such extensions are commensurate with the amount and difficulty of added Work.
 - 2. Should the aggregate amount of altered Work exceed the 25% limitation specified above, such excess altered Work will be covered by Supplemental Agreement. If the Owner and the Contractor are unable to agree on a unit adjustment for any Contract item that requires a Supplemental Agreement, the Owner reserves the right to terminate the Contract with respect to the item and make other arrangements for its completion.

7.02 CHANGE ORDERS

- A. A Change Order is a written instrument prepared by the Owner and signed by the Owner, Contractor and Design Professional, stating their agreement upon all of the following:
 - 1. a change in the Work;
 - 2. the amount of the adjustment in the Contract Sum, if any;
 - 3. the extent of the adjustment in the Contract Time, if any; and
 - 4. changes to the terms and conditions of this Contract including the W/MBE or DBE percentage, if any.
- B. Methods used in determining adjustments to the Contract Sum will include those listed in Paragraph 7.03 B.1.
- C. Supplemental Agreement. A written agreement between the Contractor and the Owner covering (1) work that would increase or decrease the total amount of the awarded Contract, or any major Contract item, by more than 25%, such increased or decreased Work being within the scope of the originally awarded Contract; or (2) Work that is not within the scope of the originally awarded Contract.

7.03 CONSTRUCTION CHANGE DIRECTIVES

- A. A Construction Change Directive is a written order prepared by the Owner or Design Professional and signed by the Owner, directing a change in the Work and stating a proposed basis for adjustment, if any, in the Contract Sum, Contract Time, or both. The Owner may by Construction Change Directive, without invalidating the Contract, order changes in the Work within the general scope of the Contract consisting of additions, deletions or other revisions, the Contract Sum and Contract Time being adjusted accordingly.
- B. A Construction Change Directive will be used in order to expedite the Work and avoid or minimize delays in the Work which may affect the Contract Sum or Contract Time. When determined by the Owner to be in the Owner's best interest, the Owner may, with or without the Contractor's agreement, direct or order the Contractor to proceed with changes in the Work by the issuance of a Construction Change Directive.
 - 1. If the Construction Change Directive provides for an adjustment to the Contract Sum, the adjustment will be based on one of the following methods:
 - a. Mutual acceptance of a lump sum, properly itemized and supported by sufficient substantiating data to permit evaluation;
 - b. By unit prices stated in the Contract Documents or otherwise mutually agreed upon;
 - c. By the cost estimated method as described in Paragraph 7.03 C., plus the accepted percentage, if applicable. The Contractor's estimate will become a fixed price which will not be changed by any variation in the actual cost of executing the Work covered by the change;
 - d. Cost to be determined in a manner agreed upon by the parties, plus, if applicable, percentage; or

- e. As provided in Paragraph 7.03 F., by actual cost determined after the Work covered by the change is completed, plus, if applicable, percentage.
 2. As used in this Paragraph 7.03, Construction Change Directive's "cost" will mean the estimated or actual net increase in cost to the Contractor or Subcontractor for performing the Work covered by the change, including actual payments for materials, equipment rentals, expendable items, wages and associated benefits to workers and to supervisors employed full time at the site where the Work is performed, insurance, bonds, and other provable direct costs, but not including any administrative, accounting or expediting costs, or other indirect or overhead costs, or any wages or benefits of supervisory personnel not assigned full time to the site, or any amount for profit or fee to the Contractor, Subcontractor, or Sub-Subcontractor. Rates for the Contractor and Subcontractor owned equipment will not exceed the rates listed in the Associated Equipment Distributors rental rate book as adjusted to the regional area of the Work under this Contract.
 3. "Percentage" will mean an amount to be added to the cost for overhead and profit and any other expense which is not included in the cost of the Work covered by the change, as defined above. The maximum percentage for total overhead and profit and any other expense which is not included in the cost of the Work will be as follows:
 - a. For the Contractor, 15% of any net increase of costs of any Work performed by the Contractor's own forces on-site only.
 - b. For the Subcontractor, 10% of any net increase of cost of any Work performed by the Subcontractor's own forces on-site only, plus 5% of any net increase in the cost of the Work for the Contractor on-site only.
 - c. Per the Contract negotiations and as noted in the exhibit(s).
 4. When in the reasonable judgment of the Owner a series of Construction Change Directives or Change Orders affect a single change, the percentage will be calculated on the cumulative net increase in cost, if any.
 5. Overhead will include the following:
 - a. Supervision wages, timekeepers, watchmen and clerks, hand tools, incidentals, general office expense, and all other expenses not included in "cost."
- C. Upon request of the Owner, the Contractor will, without cost to the Owner, submit to the Owner, in such form as the Owner may require an accurate written estimate of the cost of any proposed extra work or change. The estimate will indicate the quantity and unit cost of each item of materials, and the number of hours of work and hourly rate for each class of labor, as well as the description and amounts of all other costs chargeable under the terms of this Part. Unit labor costs for the installation of each item of materials will be shown if required by the Owner. The Contractor will promptly revise and resubmit such estimate if the Owner determines that it is not in compliance with the requirements of this Part, or that it contains errors of fact or mathematical errors.

1. If required by the Owner, in order to establish the exact cost of new Work added or of previously required Work omitted, the Contractor will obtain and furnish to the Owner bona fide proposals from recognized suppliers for furnishing any material included in such Work. Such estimates will be furnished promptly so as to occasion no delay in the Work and will be furnished at the Contractor's expense. The Contractor will state in the estimate any extension of time required for the completion of the Work if the change or extra work is ordered.
- D. Upon receipt of a Construction Change Directive, the Contractor will promptly proceed with the change in the Work involved and advise the Owner of the Contractor's agreement or disagreement with the method provided in the Construction Change Directive for determining the proposed adjustment in the Contract Sum and/or Contract Time.
- E. A Construction Change Directive signed by the Contractor indicates the agreement of the Contractor therewith, including the adjustment in Contract Sum and/or Contract Time or the method for determining them. Such agreement will be effective immediately and will be subsequently recorded in/as a Change Order.
- F. If the Contractor does not respond promptly or disagrees with the method for adjustment of the Contract Sum, the method and the adjustment will be determined by the Owner on the basis of reasonable expenditures and savings of those performing the Work attributable to the change, including, in case of an increase in the Contract Sum, a percentage for overhead and profit. In such case, and also under Paragraph 7.03 B.1.(e), the Contractor will keep and present, in such form as the Owner may prescribe, an itemized accounting together with appropriate supporting data. Unless otherwise provided in the Contract Documents, costs for the purposes of this Subparagraph will be limited to the following:
 1. Costs of labor, including social security, old age and unemployment insurance, fringe benefits required by agreement or custom, and workers' compensation insurance;
 2. Costs of materials, supplies and equipment, including costs of transportation, whether incorporated or consumed;
 3. Rental costs of machinery and equipment, exclusive of hand tools, whether rented from the Contractor or others; and
 4. Costs of premiums for all bonds and insurance, permit fees, and sales, use or similar taxes related to the Work.
- G. The amount of credit to be allowed by the Contractor to the Owner for a deletion or change which results in a net decrease in the Contract Sum will be actual net cost as confirmed by the Owner. When both additions and credits covering related Work or substitutions are involved in a change, the percentage for overhead and profit will be figured on the basis of net increase, if any, with respect to that change.
- H. If the Owner and Contractor do not agree with the adjustment in Contract Time or the method for determining it, the adjustment or the method will be referred to the Design Professional for determination.

- I. When the Owner and Contractor agree with the determination made by the Design Professional concerning the adjustments in the Contract Sum and/or Contract Time, or otherwise reach agreement upon the adjustments, such agreement will be effective immediately and will be subsequently recorded in preparation and execution of an appropriate Change Order.

7.04 MINOR CHANGES IN THE WORK

The Owner will have authority to order minor changes in the Work not involving adjustment to the Contract Sum or extension of the Contract Time and not inconsistent with the intent of the Contract Documents. Such changes will be effected by written order and will be binding on the Owner and Contractor. The Contractor will carry out such written orders promptly.

PART 8 – TIME

8.01 DEFINITIONS

- A. Unless otherwise provided, the Contract Time(s) is the period of time allotted in the Contract Documents for Substantial Completion of the Work or designated portion thereof as defined in Paragraph 8.01 C., including adjustments thereto.
- B. The date of commencement of the Work is the date established in a written notice to proceed. Work under this Contract will not commence until the Owner has issued a written notice to proceed. Notwithstanding the previous sentence, preliminary work such as procuring Insurance Policy Endorsements, Certificates of Insurance and Payment and Performance Bonds can proceed after the Contract is signed and prior to the Notice to Proceed. The Contractor will begin the work to be performed under the Contract within ten days of the date set by the Owner in a written notice to proceed but, in any event, the Contractor will notify the Owner at least 48 hours in advance of the time actual construction operations will begin. The date will not be postponed by the failure to act of the Contractor or of persons or entities for whom the Contractor is responsible.
- C. The date of Substantial Completion is the date certified by the Owner in accordance with Paragraph 9.07.
- D. The term “day” as used in the Contract Documents will mean calendar day unless otherwise specifically defined.
- E. The Contractor’s plea that insufficient Contract Time was specified will not be a valid reason for extension of Contract Time. No extension of Contract Time for completion will be granted.

8.02 PROGRESS AND COMPLETION

- A. Time limits stated in the Contract Documents are of the essence of the Contract. By executing the Contract the Contractor confirms that the Contract Time is a reasonable period for performing the Work. In the event the Contractor fails to promptly complete the Work herein within the Contract Time(s) provided, liquidated damages will accrue in the amount(s) and manner specified in the Contract.

- B. The Contractor will furnish sufficient forces, construction plant and equipment, and will work such hours, including night shifts and other overtime operations, as may be necessary to insure prosecution of the Work in accordance with the Construction Schedule. Contractor will take such steps as may be necessary or as may be directed by the Owner to improve Contractor's progress by increasing the number of shifts, overtime operations, days of work, and amount of construction plant, as may be required, at no additional cost to the Owner.
- C. Maintenance of Schedule: The Contractor will prosecute the Work with sufficient forces, materials, and equipment to maintain progress in accordance with the Construction Schedule. Should the Work in whole or in part fall behind the Construction Schedule, or should the progress of the Work appear to the Owner to be inadequate to assure completion on the completion date(s) specified in the Contract, the Contractor will, upon written notice from the Owner, take appropriate steps within seven days of such notice to put the Work back on schedule and meet the specified completion date(s).
1. Should the Contractor fail to institute appropriate measures within seven days, or should the measures taken fail to put the Work back on schedule within 14 days of such notice, the Owner may, but will not be required to, supplement the Contractor's forces, materials and/or equipment with other forces, materials and/or equipment. The cost of such other forces, materials and/or equipment will be deducted by the Owner from sums otherwise owing to the Contractor. The Owner's use of such supplemental forces, materials and/or equipment will not excuse the Contractor from performing all of its obligations under the Contract Documents or relieve the Contractor from liquidated damages. The Contractor will coordinate and work together with such supplemental forces, materials and/or equipment.
 2. Failure of the Contractor to comply with the requirements under this Paragraph will be grounds for determination that the Contractor is not prosecuting the Work with such diligence as will insure completion within the time(s) specified and such failure constitutes a material breach of the Contract Documents. Upon such determination, the Owner may terminate the Contractor's right to proceed with the Work, or any separate part thereof, in accordance with Part 13, TERMINATION OR SUSPENSION OF THE CONTRACT.
- D. The Contractor will proceed expeditiously with adequate forces and will achieve Substantial Completion within the Contract Time(s).

8.03 DELAYS AND EXTENSIONS OF TIME

- A. No claim for damages or any claim other than for an extension of time will be made or asserted against the Owner by reason of any Delay, whether such Delay is related to (i) late or early completion, (ii) delay in the commencement, prosecution or completion of the Work, (iii) hindrance or obstruction in the performance of the Work, (iv) loss of productivity, or (v) other similar claims (collectively "Delay"), whether or not such Delay is foreseeable, unless the Delay is caused by acts of the Owner constituting fraud or active interference with the Contractor's performance of the Work, and only to the extent such acts continue after Contractor furnishes the Owner with notice of such

fraud or active interference. The Contractor will not be entitled to an increase in the Contract Sum or payment or compensation of any kind from the Owner for direct, indirect, consequential, impact or other costs, expenses or damages, including but not limited to: damages related to loss of business, loss of opportunity, impact damages, loss of financing, principal office overhead and expenses, loss of profits, loss of bonding capacity and loss of reputation; costs of acceleration or inefficiency, arising because of Delay, disruption, interference or hindrance from any cause whatsoever; provided, however, that this provision will not preclude recovery of direct and actual damages by the Contractor for hindrances or delays due solely to fraud or active interference on the part of the Owner. Otherwise, the Contractor may be entitled only to extensions of the Contract Time as the sole and exclusive remedy for such resulting delay, in accordance with and to the extent specifically provided above. The Owner's exercise of any of its rights or remedies under the Contract Documents (including but not limited to, order changes in the Work, directing suspension, rescheduling or correction of the Work), regardless of the extent or frequency of Owner's exercise of such rights or remedies, shall not be construed as active interference with the Contractor's performance of the Work.

- B. Claims relating to time will be made in accordance with applicable provisions of Paragraph 4.03. Contractor's plea that insufficient time was specified will not be a valid reason for extension of the Contract time. Contract time will not be extended for a weather related delay except as provided in Paragraph 4.03.
 - 1. Permitting the Contractor to continue and finish the Work or any part of it after the time fixed for its completion, or after that date to which the time for completion may have been extended, will in no way operate as a waiver on the part of the Owner of any of its rights under the Contract.

PART 9 – PAYMENTS AND COMPLETION

9.01 CONTRACT SUM

The Contract Sum is stated in the Contract and, including authorized adjustments, is the total amount payable by the Owner to the Contractor for performance of the Work under the Contract Documents.

9.02 SCHEDULE OF VALUES

- A. Before submitting the first Application for Payment, the Contractor will submit to the Owner and the Design Professional a Schedule of Values. Refer to Section 01370 – SCHEDULE OF VALUES for additional information.
 - 1. The Schedule of Values will be approved by the Owner and the Design Professional prior to submitting the initial Application for Payment.
 - 2. The Schedule of Values will be in a form as required by the Owner and the Design Professional to adequately establish costs of the Work.
 - 3. This Schedule of Values will be prepared in such a form and supported by such data to substantiate its accuracy in reflecting the above breakdown for administrative and payment purposes as the Owner or Design Professional may

require and will be revised later if found by the Design Professional to be inaccurate. If the Contract involves multiple projects and/or airports, project and/or airport sub-totals will be required.

4. This Schedule of Values, unless objected to by either the Owner or the Design Professional, will be used only as a basis for the Contractor's Application for Payment.
5. The Schedule of Values must be sent electronically in Microsoft Excel format along with the Application for Payment.
6. Initial Payment Application: The principal administrative actions and submittals which will precede or coincide with submittal of the Contractor's first Application for Payment are as follows, but not necessarily by way of limitation:
 - a. Listing of Subcontractors and principal suppliers and fabricators.
 - b. Schedule of Values.
 - c. Initial recognized CPM (or Bar Chart) Construction Schedule.
 - d. Schedule of submittals.
 - e. Stored Material spreadsheet and verification form.
 - f. Subcontractor signed agreements.

9.03 APPLICATIONS FOR PAYMENT

- A. The Contractor will, as a condition precedent to the right to receive any monthly payment, submit to the Owner, an Application for Payment, sample attached herein and identified as Exhibit A – Aviation Authority Application for Payment.
 1. Scope of Payment: For performance of this Contract, the Owner will make payments in U.S. Dollars to the Contractor in accordance with the Owner approved Schedule of Values, which will be based on the Contract Sum amount established by the Contractor in Section 00300 – BID FORM. It is understood that the Contract Sum amount to be paid to the Contractor will be totally based on the said amount contained in Section 00300 – BID FORM and made a part of this Contract for the Work actually complete.
 - a. The Contractor will receive and accept compensation provided for in the Contract as full payment for furnishing all materials, for performing all Work under the Contract in a complete and acceptable manner, and for all risk, loss, damage, or expense of whatever character arising out of the nature of the Work or the prosecution thereof, subject to the provisions of Paragraph 11.02 G., herein.
 2. With the exception of the month of September, all notarized Applications for Payment will be submitted to the Owner by the third of each month. In the event that the third of the month falls on a Saturday, Sunday, or non-working day, Applications for Payment are due the prior business day. Payment will be made on the twenty fifth of the following month. If the twenty fifth of the subsequent month falls on a Saturday, Sunday or non-working day, then

payment will be made on the next business day. Applications for Payment submitted more than 25 days prior to the third of the month will be rejected and returned. Due to the end of fiscal year financial closeout, September Applications for Payment will be required to be submitted by September 12th, and in the event that the 12th falls on a Saturday, Sunday, or non-working day, Applications for Payment are due the next business day and a subsequent payment will be made the second Friday of October. The Owner requires the Contractor to have a pencil copy review and approval of all Applications for Payment with the Owner's Construction Project Manager prior to their submittals.

3. The Contractor will submit to the Owner via email to AppforPayment@TampaAirport.com, one electronic copy of an executed and notarized original of an itemized Application for Payment prepared on a form that is on the CD supplied by the Owner at the pre-construction meeting and based on the agreed Schedule of Values and copy (pdf) of all submitted backup documents, supported by such data substantiating the Contractor's right to payment as the Owner or Design Professional may require and reflecting retainage for all Work performed through the last day of each month or agreed upon date. The Application for Payment will be certified by a person duly authorized in writing to execute contractual instruments on behalf of the Contractor.
 - a. Each Application for Payment will include the Contractor's signed notarized statement, based on the agreed Schedule of Values of the value of the Work. The total payment for each month will be broken down according to the specific items from the Schedule of Values that have been completed/delivered for which payment is requested. All such payments will be commensurate with the actual progress of the Work which must be substantiated and itemized in the Monthly Construction Schedule. Payment will not be made for any Work which cannot be so substantiated. Refer to Section 01315 – SCHEDULES, PHASING.
 - b. All progress payments will be subject to correction following the discovery of an error, misrepresentation, or unallowable cost in any previous Application for Payment. Approval of such erroneous Application for Payment will not in any respect be taken as an admission by the Owner of the amount of Work completed, or the release of the Contractor from any of its responsibility under the Contract.
4. The Contractor's design and construction schedule will be updated on a monthly basis and a copy thereof submitted with each of the Contractor's Applications for Payment. This schedule update shall include a thirty (30) day "look-ahead schedule", projected variances and calculation of the number of days difference between the as-built critical path and the Project Schedule critical path. Contractor shall, with each Application for Payment, provide completed monthly updated information for the previous month on the Project Schedule and updated information on manpower indicated as-built and as-planned conditions. The updated information in the Project Schedule shall not modify any milestone dates in the Project Schedule that Owner has previously

approved. The Owner will not approve for payment an Application for Payment not containing the Contractor's submission of an approved monthly design and construction schedule update. Refer to General Requirements Section 1315 – SCHEDULES, PHASING.

5. In addition to the schedule updates required above, with each Application for Payment, Contractor shall, in addition to documentation required under the Contract, submit the following information which is required to process any Application for Payment including a monthly status report concisely but completely describing in narrative form, the current status of the Work including, without limitation:
 - a. A review of actual progress during the month in comparison to the Project Schedule and, if actual progress is behind schedule, discussion of any "work around" or "catch up plan" that Contractor has employed or will employ to recover the original Project Schedule;
 - b. A concise statement of the outlook for meeting future Project Schedule dates, and the reasons for any change in outlook from a previous report;
 - c. A concise statement of significant progress on major items of Work during the report period, with progress photographs as necessary to document the current status of the Work;
 - d. A review of any significant technical problems encountered during the pay application period and the resolution or plan for resolution of the problems;
 - e. An explanation of any corrective action taken or proposed;
 - f. A complete review of the status of Change Orders, including a review of any changes in the critical path for the Project Schedule which result from Change Orders approved by Owner during the month, as well as a review of the schedule impact of Change Order requests then pending;
 - g. A summary of any claims anticipated by the Contractor with respect to the Work, including the anticipated cost and schedule impacts of any such claims;
 - h. A cumulative summary of the number of days of, and the extent to which the progress of the Work was delayed by, any of the causes for which Contractor could be entitled to an extensions of the Contract Time; and
 - i. An updated material purchase log.
6. Further, the Design Professional will not recommend for payment by the Owner an Application for Payment without satisfactory documentation of material and services purchases scheduled to have been issued during the period of time covered by the Application for Payment. Copies of issued Purchase Orders and Contract (subcontracts) will be considered satisfactory documentation. Refer to Section 01315 – SCHEDULES, PHASING.
 - a. Entries will match current data of the Schedule of Values and Construction Schedule. Listing will include amounts of fully executed Change Orders per project approved by the Owner prior to the last day

of the “period of work” covered by the Application for Payment. Incomplete Applications for Payment will be returned by the Owner without action.

- b. For Contracts with a prescribed DBE or W/MBE goal or participation, the Contractor will submit via email to AppforPayment@TampaAirport.com with each Application for Payment the completed Commitment Form showing the detailed accounting for all DBE or W/MBE participation as applicable. Contractor will submit one (1) in electronic format.

This accounting will include:

- (1) the names and addresses of DBE or W/MBE firms that have participated on the Contract;
- (2) a description of the Work each named DBE or W/MBE form has performed; and
- (3) the value of Work performed by each named DBE or W/MBE firm;
- (4) addition or replacement of approved DBE or W/MBE firms;
- (5) at 50% completion – a plan of action properly reflecting anticipated DBE or W/MBE achievement of commitment.

7. The Contractor will submit with each Application for Payment a detailed accounting of the value of Work performed to date by their Subcontractors. Submission detail will be organized identifying the supporting information.

This accounting will include:

- a. the names and addresses of their Subcontractors that have participated on the Contract;
- b. a description of the Work each of their Subcontractors has performed;
- c. the value of Work performed by each of their Subcontractors;
- d. fully signed Subcontractor agreements;
- e. copies of statutory Waivers of Right to Claim against the Payment Bond given by each subcontractor, supplier, and sub – contractor and supplier for sub-contractor for the period up to the date of the Application for Payment; and
- f. equipment purchased for and paid by the Owner must be identified when invoiced so that an asset tag can be attached to that equipment. A detail listing in Excel format must be submitted with the invoice when equipment is purchased. Final accounting for all assets will be performed at the completion of the project. Any assets unaccounted for will be reimbursed to the Owner.

8. The Design Professional will not recommend for payment by the Owner an Application for Payment without the Contractor's submission of the detailed DBE or W/MBE accounting.
9. The Design Professional will approve or disapprove the Contractor's Application for Payment within seven days after the receipt thereof and, upon approval, promptly issue to the Owner an Application for Payment recommending payment to the Contractor. Upon receipt by the Owner of the approved Application for Payment, the Owner will make payment according to the Owner's standard payment procedures following the month in which the Application for Payment was submitted. The Contractor agrees to pay each Subcontractor for satisfactory performance of its subcontract within 10 days after the Contractor's receipt of payment from the Owner. The Contractor agrees further to release retainage payments to each Subcontractor within 10 days upon receipt from Owner and after the Subcontractor's work is satisfactorily completed. Any delay or postponement of payment from the above referenced time frame may occur only for good cause following written notice to the Owner. This clause applies to both DBE or W/MBE and non-DBE or W/MBE subcontractors.
10. The Owner will pay to Contractor 90% of all Applications for Payment submitted by Contractor to the Design Professional, said Applications for Payment to represent the value, based on the Contract amount, of the Work satisfactorily performed on the Schedule of Values, less the aggregate of all previous payments. The Application for Payment will reflect a retainage of 10% of the total amount payable for Work satisfactorily completed to date.

Until 50% of the total Contract Sum has been expended, the Owner will pay to Contractor 90% of all Applications for Payment submitted by Contractor. The Applications for Payment will represent the actual value, based on the Contract amount, of the Work satisfactorily performed on the Schedule of Values, less the aggregate of all previous payments and will reflect a retainage of 10% of the total amount payable for Work satisfactorily completed to date. Upon written request from the Contractor, retainage may be released to the Contractor, in the sole discretion of the Owner, for the Work or designated portions thereof upon reaching Substantial Completion, as defined in Section 9.07, Substantial Completion. Any amounts that are the subject of a good-faith dispute, the subject of a claim brought pursuant to F.S. § 255.05, or are otherwise the subject of a claim or demand, will not be released. Retainage will not be withheld on design and construction administration fees, if any. After 50% completion, the retainage withheld may be reduced to 5% from each subsequent application for payment.

The Contractor is required to pay all subcontractors for satisfactory performance of their contracts no later than 20 days after the Contractor has received a partial payment. The Contractor is required to fully pay retainage to the subcontractor within 20 days after the subcontractor's work is satisfactorily completed. A subcontractor's work is satisfactorily completed when (1) all the tasks called for in the subcontract have been accomplished and documented as required by the Owner, (2) the Work or a designated portion of the Work which the subcontractor worked on has reached

Substantial Completion (incremental acceptance) and (3) no good-faith disputes or claims involving the subcontractor have manifested.

Notwithstanding the foregoing, at the Owner's sole option, when at least 95% of the Work has been completed, the Engineer shall, at the Owner's discretion and with the consent of the surety, prepare estimates of both the contract value and the cost of the remaining work to be done. Subject to Fla. Stat. 255.078 (if applicable), the Owner may retain an amount not less than twice the contract value or estimated cost, whichever is greater, of the work remaining to be done. Upon written request from the Contractor, the remainder (if any) may be released to the Contractor.

Notwithstanding the foregoing, at the Contractor's option, the Contractor may request that the Owner deposit the retainage into an escrow account. The Owner's deposit of retainage into an escrow account is subject to the following conditions:

- a. The Contractor shall bear all expenses of establishing and maintaining an escrow account and escrow agreement acceptable to the Owner.
- b. The Contractor shall deposit to and maintain in such escrow only those securities or bank certificates of deposit as are acceptable to the Owner and having a value not less than the retainage that would otherwise be withheld from partial payment.
- c. The Contractor shall enter into an escrow agreement satisfactory to the Owner.
- d. The Contractor shall obtain the written consent of the surety to such agreement.

11. In addition, the Owner may withhold or suspend additional payments or portions thereof to such extent as may be necessary to protect itself from loss on account of:

- a. Work or execution thereof not performed or not in accordance with the Contract Documents.
- b. The cost of the Work performed by the Owner, or contracted to others by the Owner, on behalf of the Contractor where said Work or the costs thereof are identified in the Contract Documents as the responsibility of the Contractor.
- c. Whether items of Work remain to be corrected or completed following Substantial Completion or Final Acceptance.
- d. Non-compliance with the Owner's DBE or W/MBE Policy or failure to meet the prescribed DBE goal or W/MBE expectancy set forth in this Contract, or to establish a good faith effort to do so.

(1) Failure of the Contractor to make a good faith effort to achieve DBE goal or W/MBE goal may be a material breach of this Contract. The determination of whether the Contractor's efforts were made in "good faith" will be made by the Owner.

(2) Unless otherwise provided in the Contract Documents, payment will only be for Work in place.

- e. Other non-compliance with the Contract, Owner Policies or Procedures.
- B. The Owner will have the right to omit or order non-performance of a portion of the Work in the best interest of the Owner.
- 1. Should the Owner omit or order non-performance of a portion of the Work, the Contract Sum will be reduced accordingly. However, the Contractor will be paid for any such work actually completed and acceptable prior to the order to omit or non-perform.
 - 2. Should the Owner omit or order non-performance of a portion of the Work, acceptable materials ordered by the Contractor or delivered to the Work prior to the date of the Owner's order will be paid for at the actual cost to the Contractor and will become the property of the Owner.
 - 3. In addition to the reimbursement hereinbefore provided, the Contractor shall be reimbursed for all actual costs incurred for the purpose of performing the omitted Contract item prior to the date of the Owner's order. Such additional costs incurred by the Contractor must be directly related to the deleted Contract item and will be supported by certified statements by the Contractor as to the nature the amount of such costs.
- C. Payments may be made on account of non-perishable materials or equipment not incorporated in the Work but delivered and suitably stored at the site, upon the following conditions being met:
- 1. The Materials have been stored or stockpiled in a manner acceptable to the Owner and Design Professional.
 - 2. The Contractor has furnished the Design Professional with satisfactory evidence that the materials and transportation costs have been paid.
 - 3. The Contractor has furnished the Design Professional with acceptable evidence of the quantity and quality of such stored or stockpiled materials.
 - 4. The Contractor has furnished the Owner legal title (free of liens or encumbrances of any kind) to materials so stored or stockpiled.
 - 5. The Contractor has furnished to the Owner and Design Professional copies of paid invoices of all stored materials and all stored material listed in Excel format and as a hard copy and a stored material verification form. All supporting backup must be labeled with the Schedule of Values item number and calculation of item number listed on the Schedule of Values.
 - 6. Documentation that all material meets specification requirements.
 - 7. The Contractor will be responsible for all loss or damage of any type to such materials or equipment and will make suitable replacement or repair as necessary at the Contractor's own expense.

8. The Contractor will be responsible for security with respect to all such stored materials and equipment.
 9. The Contractor has furnished the Owner evidence that the material so stored or stockpiled is insured against loss by damage to or disappearance of such materials at any time prior to use in the Work.
 10. Payments for material on hand for delivered material to be used in one item of Work must exceed \$3,000.00, and not scheduled to be incorporated into the work within sixty days after delivery.
 11. It is understood and agreed that the transfer of title and the Owner's payment for such stored or stockpiled materials will in no way relieve the Contractor of its responsibility for furnishing and placing such materials in accordance with the requirements of the Contract Documents.
 12. No partial payment will be made for stored or stockpiled living or perishable plant materials.
 13. The Contractor will bear all costs associated with the partial payment of stored or stockpiled materials in accordance with the provisions of this subsection.
 14. In no case will the amount of payments for materials on hand exceed the Contract Price for such materials or the Contract Price for the Contract Item in which the material is intended to be used.
- D. The Contractor warrants that title to all work covered by an Application for Payment will pass to the Owner upon receipt of payment by the Contractor. The Contractor further warrants that upon submittal of an Application for Payment, all work for which certificates for payment have been previously issued and payments received from the Owner will, to the best of the Contractor's knowledge, information and belief, be free and clear of liens, claims, security interests or encumbrances (hereinafter referred to in this Part as liens) in favor of the Contractor, Subcontractors, material suppliers, or other persons or entities making a claim by reason of having provided labor, materials or equipment relating to the Work.

9.04 CERTIFICATES FOR PAYMENT

- A. The Design Professional will, within seven days after receipt of the Contractor's Application for Payment, either issue to the Owner a Certificate for Payment, with a copy to the Contractor, for such amount as the Design Professional determines is properly due, or notify the Contractor and Owner in writing of the Design Professional's reasons for withholding certification in whole or in part as provided in Subparagraph 9.05 A.
- B. The issuance of a Certificate for Payment will constitute a representation by the Design Professional to the Owner, based on the Design Professional's observations at the site and review of the data comprising the Application for Payment, that the Work has progressed to the point indicated and that, to the best of the Design Professional's knowledge, information and belief, the quality of the Work is in accordance with the Contract Documents. The foregoing representations are subject to an evaluation of the Work for conformance with the Contract Documents upon Substantial Completion, to results of subsequent tests and inspections, to minor deviations from the Contract

Documents correctable prior to completion and to specific qualifications expressed by the Design Professional. The issuance of a Certificate for Payment will further constitute a representation that the Contractor is entitled to payment in the amount certified. However, the issuance of a Certificate for Payment will not be a representation that the Design Professional has (1) made exhaustive or continuous on-site inspections to check the quality or quantity of the work, (2) reviewed construction means, methods, techniques, sequences or procedures, or (3) made examination to ascertain how or for what purpose the Contractor has used money previously paid on account of the Contract Sum.

- C. In taking action on the Contractor's Applications for Payment, the Design Professional will be entitled to rely on the accuracy and completeness of the information furnished by the Contractor and will not be deemed to represent that the Design Professional has made a detailed examination, audit or arithmetic verification of the documentation submitted in accordance with Subparagraph 9.04 B. or other supporting data, that the Design Professional has made exhaustive or continuous on-site inspection or that the Design Professional has made examinations to ascertain how or for what purposes the Contractor has used amounts previously paid on account of the Contract. Such examinations, audits and verifications, if required by the Owner will be performed by the Owner, acting in the sole interest of the Owner.

9.05 DECISIONS TO WITHHOLD CERTIFICATION

- A. The Design Professional may decide not to certify the Application for Payment and may withhold a Certificate for Payment in whole or in part, to the extent reasonably necessary to protect the Owner, if in the Design Professional's opinion the representations to the Owner required by Subparagraph 9.04 B. cannot be made. If the Design Professional is unable to certify payment in the amount of the Application for Payment, the Design Professional will notify the Contractor and Owner as provided in Subparagraph 9.04 A. If the Contractor and Design Professional cannot agree on a revised amount, the Design Professional will promptly issue an Application for Payment for the amount for which the Design Professional is able to make such representations to the Owner. The Design Professional may also decide not to certify payment, or because of subsequently discovered evidence or subsequent observations may nullify the whole or a part of a Certificate for Payment previously issued, to such extent as may be necessary in the Design Professional's opinion to protect the Owner from loss because of:
 - 1. defective Work not remedied;
 - 2. third party claims filed or reasonable evidence indicating probable filing of such claims;
 - 3. failure of the Contractor to make payment properly to Subcontractors or for labor, materials or equipment;
 - 4. reasonable evidence that the Work cannot be completed for the unpaid balance of the Contract Sum;
 - 5. damage to the Owner or another Contractor;

6. reasonable evidence that the Work will not be completed within the Contract Time and that the unpaid balance would not be adequate to complete the Work and to cover actual or liquidated damages for the anticipated delay;
 7. persistent failure to carry out the Work in accordance with the Contract Documents; and/or
 8. failure of the Contractor to provide satisfactory documentation of material and services purchased in accordance with the Construction Schedule.
 9. other failure of the Contractor to comply with the Contract, Owner Policies or Procedures.
- B. When the above reasons for withholding certification are removed, certification will be made for amounts previously withheld.

9.06 PROGRESS PAYMENTS

- A. After the Design Professional has certified the Application for Payment, the Owner will endeavor to make payment according to the Owner's standard payment procedures. If deficiencies are found, a standard deficiency e-mail will be sent to the Contractor to resolve within 24 hours. If the deficiency is not resolved within that time, the Application will be returned.
- B. Prompt Payment Clause. The Contractor agrees to pay each subcontractor under the Contract for satisfactory performance of its contract no later than 10 days from the receipt of each payment the Contractor receives from the Owner. The Contractor agrees further to release retainage payments to each subcontractor upon receipt from Owner and within 10 days after the subcontractor's work is satisfactorily completed. Any delay or postponement of payment from the above-referenced time frame may occur only for good cause following written notice to the Owner. This clause applies to both D/W/MBE and non-D/W/MBE subcontractors.
- C. Neither the Owner nor the Design Professional will have an obligation to pay or to see to the payment of money to a Subcontractor, Sub-Subcontractor or material supplier.
- D. The payment of any Application for Payment prior to Final Acceptance of the Work by the Owner will in no way constitute an acknowledgement of the acceptance of the Work, or in any way prejudice or affect the obligation of the Contractor to repair, correct, renew, or replace, at the Contractor's expense, any defects, imperfections or design errors or omission in the design, construction, or in the strength or quality of the equipment or materials used in or about the construction of the Work under Contract and its appurtenances, or any damage due or attributed to such defects, which defect, imperfection, or damage will have been discovered on or before the Final Acceptance of the Work. The Contractor will be liable to the Owner for failure to correct same as provided herein.
- E. An Application for Payment, a certified progress payment, or partial or entire use or occupancy of the Project by the Owner will not constitute acceptance of Work not in accordance with the Contract Documents.

- F. The Owner may deduct from the balance due the Contractor under the provisions of the Contract Documents any liquidated damages which may have accrued.
- G. Provision for assessment of liquidated damages for delay will in no manner affect the Owner's right to terminate the Contract as provided in Part 13, TERMINATION OR SUSPENSION OF THE CONTRACT or elsewhere in the Contract Documents. The Owner's exercise of the right to terminate will not release the Contractor from its obligation to pay said liquidated damages in the amounts set out in the Contract.

9.07 SUBSTANTIAL COMPLETION

- A. Substantial Completion is the stage in the progress of the Work when the Work or designated portion thereof is sufficiently complete in accordance with the Contract Documents so the Owner can occupy or utilize the Work for its intended use.
- B. When the Contractor considers that the whole Work, or a portion thereof designated in the Contract Documents for separate completion, is substantially complete and the premises comply with Paragraph 3.13 A., the Contractor will submit to the Design Professional: (1) the permits and certificates referred to in Paragraph 12.05 D., and (2) the Contractor's request for inspection by the Owner and Design Professional.
 - 1. The Owner and Design Professional will then make an inspection to determine whether the Work or designated portion thereof is substantially complete. If the inspection discloses any item which is not in accordance with the requirements of the Contract Documents, the Design Professional will then prepare and submit to the Contractor a comprehensive list of items to be completed and/or corrected. The Contractor will proceed promptly to complete and correct items on the list before issuance of the Certificate of Substantial Completion by the Owner. The Contractor will then submit a request for another inspection to determine Substantial Completion. Repeat inspections will be performed prior to issuance of the Certificate of Substantial Completion by the Owner.
 - 2. All Work items or Contract requirements which remain incomplete/unsatisfied at the Date of Substantial Completion will become part of the Final Acceptance punch list. For projects with a value under \$10 million, within 30 days after Substantial Completion, the Owner will develop the Final Acceptance punch list and will provide it to the Contractor within five days after its completion. The Contractor will be allowed a minimum of 30 days after delivery of the Final Acceptance punch list to complete the items listed on the Final Acceptance punch list. However, for projects with a value over \$10 million, within 60 days after Substantial Completion, the Owner will develop the Final Acceptance punch list and will provide it to the Contractor within five days after its completion. The Contractor will be allowed a minimum of 30 days after delivery of the Final Acceptance punch list to complete the items listed on the Final Acceptance punch list.
 - 3. When the Work or designated portion thereof is substantially complete, the Owner will prepare a Certificate of Substantial Completion which will establish: the date of Substantial Completion; responsibilities of the Owner and

Contractor for security, maintenance, heat, utilities, damage to the Work; and insurance. All Warranties required by the Contract Documents will commence on the date of Substantial Completion. The Certificate of Substantial Completion will be submitted to the Design Professional and Contractor for their written acceptance of responsibilities assigned to them in such Certificate.

- C. Upon Substantial Completion of the whole Work and upon application by the Contractor and certification by the Design Professional, the Owner will make payment, reflecting adjustment in retainage, if any, for such Work as provided in the Contract Documents.
- D. After Substantial Completion of the whole Work, the Design Professional may, at the Design Professional's discretion and with the consent of the Contractor's Surety, approve an Application for Payment from which will be retained an amount not less than 1.5 times the Contract value or 1.5 times the estimated cost, whichever is greater, of the Work remaining to be done. Remaining retainage will be released with Final Payment after Final Acceptance of the whole Work.
- E. After Substantial Completion, closeout documents as required in Section 01700, Project Closeout, can be submitted to the Owner. The Owner will provide a detailed list of the closeout documents required after receipt and acceptance of the Final Acceptance punch list.

9.08 PARTIAL OCCUPANCY OR USE

- A. The Owner or separate contractors may occupy or use any completed or partially completed portion of the Work at any stage. Such partial occupancy or use may commence whether or not the portion is substantially complete. When the Contractor considers a portion substantially complete, the Contractor will prepare and submit a list to the Design Professional as provided under Subparagraph 9.07 B.
- B. Immediately prior to such partial occupancy or use, the Owner, Contractor and Design Professional will jointly inspect the area to be occupied or portion of the Work to be used in order to determine and record the condition of the Work.
- C. Unless otherwise agreed upon, partial occupancy or use of a portion or portions of the Work will not constitute acceptance of the Work not complying with the requirements of the Contract Documents.

9.09 FINAL COMPLETION AND FINAL PAYMENT

- A. Upon receipt of written notice that inspection of the whole Work is ready for Final Acceptance, the Owner and Design Professional will promptly make such inspection and, when the Owner and Design Professional finds the Work acceptable under the Contract Documents and the Contract fully performed, the Owner will promptly issue a Certificate of Final Acceptance stating that to the best of the Owner's and Design Professional's knowledge, information and belief, and on the basis of the Owner's and Design Professional's observations and inspections, the Work has been completed in accordance with terms and conditions of the Contract Documents. The Design Professional's Certification of the Final Application for Payment will constitute a further representation that conditions listed in Paragraph 9.09 B. as precedent to the

Contractor's being entitled to Final Application for Payment have been fulfilled. In the Final Certificate for Payment, the Design Professional will state the date on which the whole Work was fully complete and acceptable, which date will be the date of Final Acceptance.

- B. Neither final payment nor any remaining retained percentage will become due until the Contractor submits to the Design Professional (1) an affidavit that payrolls, bills for materials and equipment, and other indebtedness connected with the Work for which the Owner or the Owner's property might be responsible or encumbered (less amounts withheld by Owner) have been paid or otherwise satisfied, (2) a certificate evidencing that insurance required by the Contract Documents to remain in force after final payment is currently in effect and will not be cancelled or allowed to expire until at least 30 days' prior written notice has been given to the Owner, (3) a written statement that the Contractor knows of no substantial reason that the insurance will not be renewable to cover the period required by the Contract Documents, (4) consent of surety, if any, to final payment, (5) all final certified payrolls, and (6) if required by the Owner, other data establishing payment or satisfaction of obligations, such as receipts, releases and waivers of liens, claims, security interests or encumbrances arising out of the Contract, to the extent and in such form as may be designated by the Owner. If the Contractor fails to furnish such releases or waivers as the Owner reasonably requires satisfying the Owner that there are no outstanding liens, the Owner may require the Contractor, at the Contractor's expense, to furnish a bond satisfactory to the Owner to indemnify the Owner against such liens. If such lien remains unsatisfied after payments are made, the Contractor will refund to the Owner all money that the Owner may be compelled to pay in discharging such lien, including all costs and reasonable attorneys' fees. Upon satisfactory final acceptance of all Work required by the Contract Documents, receipt of notice of final acceptance from the Design Professional and compliance with project closeout of Section 01700 – PROJECT CLOSEOUT, the Contractor will make Application for Final Payment in the same format as progress payments.
- C. Acceptance of final payment by the Contractor, a Subcontractor or material supplier will constitute a waiver of claims by that payee except those previously made in writing and identified by that payee as unsettled at the time of Final Application for Payment. Such waivers will be in addition to the waiver described in Subparagraph 4.03 D.
- D. All closeout documentation shall be furnished at least seven days before submission of Application for Final Payment.

PART 10 – PROTECTION OF PERSONS AND PROPERTY

10.01 SAFETY PRECAUTIONS AND PROGRAMS

The Contractor will be responsible for initiating, maintaining and supervising all safety precautions and programs in connection with the performance of the Contract.

10.02 SAFETY OF PERSONS AND PROPERTY

- A. The Contractor will take reasonable precautions for safety of, and will provide reasonable protection to prevent damage, injury or loss to;

1. employees performing Work and other persons who may be affected thereby;
 2. the Work and materials and equipment to be incorporated therein, whether in storage on or off the site, or under care, custody or control of the Contractor or the Contractor's Subcontractors or Sub-Subcontractors;
 3. other property at the site or adjacent thereto, such as trees, shrubs, lawns, walks, pavements, roadways, structures and utilities not designated for removal, relocation or replacement in the course of construction; and
 4. any other property of the Owner, or construction by separate contractors.
- B. The Contractor will give notices and comply with applicable laws, ordinances, rules, regulations and lawful orders of public authorities bearing on safety of persons or property or their protection from damage, injury or loss.
- C. The Contractor will erect and maintain, as required by existing conditions and performance of the Contract, reasonable safeguards for safety and protection, including posting danger signs and other warnings against hazards, promulgating safety regulations and notifying Owners and users of adjacent sites and utilities.
- D. When use or storage of explosives or other hazardous materials or equipment or unusual methods are necessary for execution of the Work, the Contractor will exercise utmost care and carry on such activities under supervision of properly qualified personnel.
- E. The Contractor will promptly remedy damage and loss to property referred to in Paragraphs 10.02 A.2. and 10.02 A.3. caused in whole or in part by the Contractor, a Subcontractor, a Sub-Subcontractor, or anyone directly or indirectly employed by any of them, or by anyone for whose acts they may be liable, except damage or loss solely attributable to acts or omissions of the Owner or Design Professional or anyone directly or indirectly employed by either of them, or by anyone for whose acts either of them may be liable, and not attributable to the fault or negligence of the Contractor. The foregoing obligations of the Contractor are in addition to the Contractor's obligations under Paragraph 3.18.
- F. The Contractor will designate a competent person of the Contractor's organization at the site whose duty will be the prevention of accidents. This person will be the Contractor's superintendent unless otherwise designated by the Contractor in writing to the Owner and Design Professional.
- G. The Contractor will not load or permit any part of the construction or site to be loaded so as to endanger its safety.
- H. The Contractor will comply with the provisions of the Occupational Safety and Health Act of 1970, 84 Stat. 1190, 29 U.S.C. 611 et seq. (as amended), and applicable regulations and requirements under said Act. The Contractor will maintain an accurate record of all accidents causing death, traumatic injury, occupational disease, or damage to property, materials, supplies and equipment incidental to Work performed under this Contract.

- I. The Contractor will be responsible for the preservation of all public and private property and will protect carefully from disturbance or damage all land monuments and property markers until the Design Professional has witnessed or otherwise referenced their location and will not move them until directed.
- J. The Contractor will be responsible for all damage or injury to property of any character during the prosecution of the Work resulting from any act, omission, neglect, or misconduct in the Contractor's manner or method of executing the Work, or at any time due to defective Work or materials, and said responsibility will not be released until the Project will have been completed and accepted.
- K. When or where any direct or indirect damage or injury is done to public or private property by or on account of any act, omission, neglect, or misconduct in the execution of the Work, or in consequence of the non-execution thereof, by the Contractor, Contractor will restore, such property, at the Contractor's own expense, to a condition similar or equal to that existing before such damage or injury was done, by repairing, or otherwise restoring, as may be directed, or Contractor will make good such damage or injury in an acceptable manner.
- L. Work that is to remain in place which is damaged or defaced by reason of Work performed under this Contract will be restored at no additional cost to the Owner.
- M. Until the Design Professional's Final Written Acceptance of the whole Work, excepting only those portions of the Work accepted in accordance with Paragraph 9.07 B. herein, the Contractor will have the charge and care thereof and will take every precaution against injury or damage to any part due to the action of the elements or from any other cause, whether arising from the execution or from the non-execution of the Work. The Contractor will rebuild, repair, restore, and make good all injuries or damages to any portion of the Work occasioned by any of the above causes before Final Completion and will bear the expense thereof.
- N. If the Work is suspended for any cause whatsoever, the Contractor will be responsible for the Work during such suspension and will take such precautions necessary to prevent damage to the Work. The Contractor will provide for normal drainage and will erect necessary temporary structures, signs, or other facilities. If the Owner orders the suspension of the Work, additional compensation or extension of time may be claimed by the Contractor. During such period of suspension of Work, the Contractor will properly and continuously maintain in an acceptable growing condition all living material in newly established plantings, seedlings, and sod furnished under the Contract, and will take adequate precautions to protect new tree growth and other important vegetative growth against injury.
- O. The Contractor will be solely responsible for the means, methods, techniques, sequences, and procedures of construction. The Contractor will be responsible to the Owner for the acts and omissions of all Contractor's employees and Subcontractors, their agents and employees, and all other persons performing any of the Work under a contract with the Contractor.

10.03 EMERGENCIES

In an emergency affecting safety of persons or property, the Contractor will act, at the Contractor's discretion, to prevent threatened damage, injury or loss. Additional compensation or extension of time

claimed by the Contractor on account of an emergency will be determined as provided in Paragraph 4.03 and Part 7, CHANGES IN THE WORK.

PART 11 – UNCOVERING AND CORRECTION OF WORK

11.01 UNCOVERING OF WORK

- A. If a portion of the Work is covered contrary to the Owner's/Design Professional's request or to requirements specifically expressed in the Contract Documents, it must, if required in writing by the Owner/Design Professional, be uncovered for the Owner's/Design Professional's observation and be replaced at the Contractor's expense without change in the Contract Time.
- B. If a portion of the Work has been covered which the Design Professional has not specifically requested to observe prior to its being covered, the Owner/Design Professional may request to see such Work and it will be uncovered by the Contractor. If such work is in accordance with the Contract Documents, costs of uncovering and replacement will, by appropriate Change Order, be charged to the Owner. If such Work is not in accordance with the Contract Documents, the Contractor will pay such costs unless the condition was caused by the Owner or a separate contractor in which event the Owner will be responsible for payment of such costs.

11.02 CORRECTION OF WORK

- A. The Contractor will promptly correct Work rejected by the Owner/Design Professional for failing to conform to the requirements of the Contract Documents, whether observed before or after Substantial Completion and whether or not fabricated, installed or completed. The Contractor will bear costs of correcting such rejected Work, including additional testing and inspections and compensation for the Design Professional's services and expenses made necessary thereby.
- B. If, within one year after the Date of Substantial Completion of the whole Work or within such longer period of time as may be prescribed by law or by the terms of any applicable special warranty required by the Contract Documents, any of the Work is found to be defective or not in accordance with the Contract Documents, the Contractor will correct it promptly after receipt of a written notice from the Owner to do so. This obligation will survive termination of the Contract. The Owner will give such notice promptly after discovery of the condition.
- C. The Contractor will remove from the site portions of the Work which are not in accordance with the requirements of the Contract Documents and are neither corrected by the Contractor nor accepted by the Owner.
- D. If the Contractor fails to correct non-conforming work within a reasonable time, the Owner may correct it in accordance with Paragraph 2.04. If the Contractor does not proceed with correction of such non-conforming work within a reasonable time fixed by written notice from the Owner or Design Professional, the Owner may remove it and store the salvageable materials or equipment at the Contractor's expense. If the Contractor does not pay costs of such removal and storage within ten days after written notice, the Owner may, upon ten additional days' written notice, sell such materials and equipment at auction or at private sale and will account for the proceeds thereof, after

deducting costs and damages that should have been borne by the Contractor, including compensation for the Owner's or Design Professional's services and expenses made necessary thereby. If such proceeds of sale do not cover costs which the Contractor should have borne, the Contract Sum will be reduced by the deficiency. If payments then or thereafter due the Contractor are not sufficient to cover such amount, the Contractor will pay the difference to the Owner.

- E. The Contractor will bear the cost of correcting destroyed or damaged construction, whether completed or partially completed, of the Owner or separate Contractors caused by the contractor's correction or removal of Work which is not in accordance with the requirements of the Contract Documents.
- F. Nothing contained in Paragraph 11.02 will be construed to establish a period of limitation with respect to other obligations which the Contractor might have under the Contract Documents. Establishment of the time period of one year as described in Subparagraph 11.02 B relates only to the specific obligation of the Contractor to correct the Work, and has no relationship to the time within which the obligation to comply with the Contract Documents may be sought to be enforced, nor to the time within which proceedings may be commenced to establish the Contractor's liability with respect to the Contractor's obligations other than specifically to correct the Work.
- G. Upon completion of the whole Work, the Owner and the Design Professional will expeditiously make final inspection in accordance with Section 01700 – PROJECT CLOSEOUT, and will notify the Contractor of Final Acceptance. Such Final Acceptance, however, will not preclude or stop the Owner from correcting any measurement, estimate, or certificate made before or after completion of the whole Work, nor will the Owner be precluded or stopped from recovering from the Contractor or Contractor's Surety, or both, such overpayment as may be sustained, by failure on the part of the Contractor to fulfill Contractor's obligations under the Contract. A waiver on the part of the Owner of any breach of any part of the Contract will not be held to be a waiver of any other or subsequent breach.
- H. The Contractor, without prejudice to the terms of the Contract, will be liable to the Owner for latent defects, fraud, or such gross mistakes as may amount to fraud, or as regards to the Owner's rights under any warranty or guaranty.

11.03 ACCEPTANCE OF NON-CONFORMING WORK

If the Owner prefers to accept Work which is not in accordance with the requirements of the Contract Documents, the Owner may do so instead of requiring its removal and correction, in which case the Contract Sum will be reduced as appropriate as determined by the Owner in its reasonable discretion. Such adjustment will be effected whether or not Final Payment has been made.

PART 12 – MISCELLANEOUS PROVISIONS

12.01 GOVERNING LAW

The Contract will be governed by the law of the State of Florida. Venue for any action, arising from or related to the Contract, will be in the Florida State Circuit Court in and for the 13th Circuit, Hillsborough County, such court having sole and exclusive jurisdiction. Confidential mediation with a mediator selected by the Owner shall be a condition precedent to litigation.

12.02 SUCCESSORS AND ASSIGNS

- A. The Owner and Contractor respectively bind themselves, their partners, successors, assigns and legal representatives to the other party hereto and to partners, successors, assigns and legal representatives of such other party in respect to covenants, contracts and obligations contained in the Contract Documents. Except as hereinafter provided, the Contractor will not assign or sublet this Contract in whole or in part without the written consent of the Owner, nor will the Contractor assign any monies due or to become due to Contractor hereunder without the previous written consent of the Owner. If the Contractor attempts to make such assignment without such consent, the Contractor will nevertheless remain legally responsible for all obligations under the Contract.
- B. The Owner reserves the right to transfer its interests herein to any other governmental body created or authorized by law to operate the Airport.

12.03 WRITTEN NOTICE

Written notice will be deemed to have been duly served if delivered in person to the individual or a member of the firm or entity or to an officer of the corporation for which it was intended, on the date of delivery, or if delivered at or sent by registered or certified mail to the last business address known to the party giving notice on the date of mailing.

12.04 RIGHTS AND REMEDIES

- A. Except as otherwise provided in the Contract Documents, duties and obligations imposed by the Contract Documents and rights and remedies available thereunder will be in addition to and not a limitation of duties, obligations, rights and remedies otherwise imposed or available by law.
- B. No action or failure to act by the Owner or Design Professional will constitute a waiver of a right or duty afforded them under the Contract, nor will such action or failure to act constitute approval of or acquiescence in a breach thereunder, except as may be specifically agreed in writing.
- C. Continued performance by the Owner as to the terms of this Contract after default by the Contractor will not be deemed a waiver by the Owner of the right to cancel for any subsequent default. Inspections, measurements or certificates issued by the Owner, payments of money, acceptance of any Work, grants of any extension of time, or any other action taken by the Owner will not operate as a waiver of any provisions of the Contract or any power therein reserved to the Owner of any rights to damages therein provided. Any waiver of any breach of Contract will not be held to be a waiver of any other or subsequent breach.
- D. To the maximum extent permitted by applicable law, Contractor agrees it will not seek equitable adjustment of the terms of this Contract and that its remedies are limited to those specified herein.

12.05 TESTS AND INSPECTIONS

- A. Tests, inspections and approvals of portions of the Work required by the Contract Documents or by laws, ordinances, rules, regulations or orders of public authorities

having jurisdiction will be made at an appropriate time. The Contractor will give the Owner and Design Professional timely notice of its readiness so the Design Professional may observe such inspections, tests or approvals conducted by the Contractor or public authorities other than the Owner. (Refer to Section 01410 – Testing Laboratory Services).

- B. If the Owner, Design Professional, or other public authorities having jurisdiction determine that portions of the Work require additional testing, inspection or approval not included under Subparagraph 12.05 A., the Design Professional will, upon written authorization from the Owner, instruct the Contractor to make arrangements for such additional testing, inspection or approval and the Contractor will give timely notice to the Owner and Design Professional of when and where such tests, inspections or approvals are to be made so the Design Professional may observe such procedures. The Owner will bear such costs except as provided in Subparagraph 12.05 C.
- C. If such procedures for testing, inspection or approval under Subparagraphs 12.05 A. and 12.05 B. reveal failure of the portions of the Work to comply with requirements established by the Contract Documents, the Contractor will bear all costs made necessary by such failure including those of repeated procedures and compensation for the Design Professional's services and expenses.
- D. The Contractor will secure and promptly deliver to the Owner or Design Professional any required certificates of testing, inspection or approval, any occupancy permits, any certificates of final inspection of any part of the Contractor's Work and any operating permits for any mechanical apparatus, such as elevators, boilers, air compressors, etc., which may be required by law to permit full use and occupancy of the premises by the Owner. Receipt of such permits or certificates by the Owner or Design Professional will be a condition precedent to Substantial Completion of the Work or designated portion thereof.
- E. Tests or inspections conducted pursuant to the Contract Documents will be made promptly to avoid unreasonable delay in the Work.
- F. Notwithstanding any dispute which may arise out of the Work, the Contractor will carry on the work and maintain effective progress to complete same within the Contract Time(s) set forth in the Contract Documents.

12.06 E-VERIFY REQUIREMENTS

The Contractor agrees to comply with the State of Florida, Office of the Governor, Executive Order Number 11-116 (Verification of Employment Status), which states that all agencies under the direction of the Governor are to include, as a condition of all state contracts for the provision of goods or services to the state in excess of nominal value, an express requirement that contractors utilize the U.S. Department of Homeland Security's E-Verify system to verify the employment eligibility of all new employees hired by the contractor during the contract term, and an express requirement that contractors include in such subcontracts the requirement that subcontractors performing work or providing services pursuant to the state contract utilize the E-Verify system to verify the employment eligibility of all new employees hired by the subcontractor during the contract term. Any projects with Florida Department of Transportation (FDOT) funding will contain this assurance as a condition for any new Joint Participation Agreements dated after January 4, 2011. The Contractor will verify all of their

new employees and will require that their subcontractors verify all of their new employees in accordance with the E-verify requirements set out above.

12.07 LOBBYING AND INFLUENCING FEDERAL EMPLOYEES - 49 CFR part 20, Appendix A

The Contractor certifies by signing and submitting its bid and this Contract, to the best of his or her knowledge and belief, that:

- A. No Federal appropriated funds have been paid or will be paid, by or on behalf of the Contractor, to any person for influencing or attempting to influence an officer or employee of an agency, a Member of Congress, an officer or employee of Congress, or an employee of a Member of Congress in connection with the awarding of any Federal contract, the making of any Federal grant, the making of any Federal loan, the entering into of any cooperative agreement, and the extension, continuation, renewal, amendment, or modification of any Federal contract, grant, loan, or cooperative agreement.
- B. If any funds other than Federal appropriated funds have been paid or will be paid to any person for influencing or attempting to influence an officer or employee of any agency, a Member of Congress, an officer or employee of Congress, or an employee of a Member of Congress in connection with this Federal contract, grant, loan, or cooperative agreement, the undersigned shall complete and submit Standard Form-LLL, "Disclosure Form to Report Lobbying," in accordance with its instructions.

This certification is a material representation of fact upon which reliance was placed when this transaction was made or entered into. Submission of this certification is a prerequisite for making or entering into this transaction imposed by section 1352, title 31, U.S. Code. Any person who fails to file the required certification shall be subject to a civil penalty of not less than \$10,000 and not more than \$100,000 for each such failure.

The Contractor or offeror must place the language of this certification in all contracts, purchase orders and other documents binding contractors, subcontractors and suppliers and require that all contractors, subcontractors and suppliers execute such certification and disclose accordingly.

This certification is a material representation of fact upon which reliance was placed when this transaction was made or entered into. Submission of this certification is a prerequisite for making or entering into this transaction imposed by section 1352, title 31, U.S. Code. Any person who fails to file the required certification shall be subject to a civil penalty of not less than \$10,000 and not more than \$100,000 for each such failure.

PART 13 – TERMINATION OR SUSPENSION OF THE CONTRACT

13.01 TERMINATION BY THE OWNER FOR CAUSE

- A. Owner may terminate this Contract for cause if the Contractor:
 - 1. Fails to commence the Work within the time specified, fails to maintain adequate progress toward completion of the Work, discontinues the prosecution of the Work, abandons the prosecution of the Work, or fails to

resume Work which has been discontinued within a reasonable time after notice to do so; or

2. Fails to perform the Work, fails to provide a sufficient number of adequately skilled workers or supervisory staff who actively staff the Project and prosecute the Work, or fails to have available at the site proper equipment or materials to assure completion of the Work in accordance with the terms of the Contract Documents; or
 3. Performs the Work unsuitably, or neglects or refuses to remove materials or to perform anew such Work as may be rejected by Owner as unacceptable or unsuitable; or
 4. Fails to comply with Contract requirements regarding minimum wage payments, EEO, W/MBE or DBE requirements; or
 5. Disregards laws, ordinances, rules, regulations or orders of any public authority having jurisdiction; or
 6. Allows any final judgment against it to remain unsatisfied for a period of 30 days; or
 7. Becomes insolvent, is declared bankrupt, files for reorganization under the bankruptcy code or commits any act of bankruptcy or insolvency, either voluntarily or involuntarily; or
 8. Makes an assignment for the benefit of creditors or attempts to assign its rights or obligations under this Contract or any part thereof to any third-party without the prior written consent of the Owner; or
 9. Consents to or is the subject of any order or decree of any court or governmental authority or agency having jurisdiction appointing a receiver, trustee, or liquidator to take possession or control of all or substantially all of the Contractor's property for the benefit of creditors; or
 10. Materially breaches any provision in this Contract; or
 11. If at any time the Surety executing the bonds is determined by the Owner to be unacceptable and the Contractor fails to furnish an acceptable substitute Surety within ten days after notice from the Owner or;
 12. Fails or refuses to perform any other obligation under this Contract, or fails to remedy such nonperformance within seven (7) days after notice of the occurrence by the Owner; or
 13. Fails to achieve the required dates of Substantial and/or Final Completion.
- B. When any of the above reasons exist, the Owner may, without prejudice to any other rights or remedies available, give notice, in writing, to the Contractor and the Contractor's Surety. If the Contractor within a period of ten days after receiving such

notice has not commenced in good faith to cure such cause or breach, or if having commenced such cure is not proceeding diligently to complete the cure, the Owner will have full power and authority, without violating this Contract, to immediately take the prosecution of the Work out of the hands of the Contractor, may declare the Contractor in default, and may terminate, in whole or in part, this Contract.

1. Upon termination of this Contract, the Owner may, subject to any prior rights of the Contractor's Surety:
 - a. Take possession of the site and of all materials, equipment, tools, electronic drawings, including but not limited to BIM models, shop drawings and machinery thereon owned by the Contractor; and
 - b. Finish the Work by whatever method the Owner may deem expedient and necessary.
- C. When the Owner terminates this Contract for cause, the Owner will be entitled to hold all amounts due the Contractor at the date of termination until completion of the Work and final evaluation of the Owner's damages associated with the termination. The Contractor will be liable to the Owner for costs and expenses incurred by the Owner in completing the Work, and also for losses, damages, costs and expenses including, but not limited to, direct, indirect and consequential damages. If such costs and expenses exceed the sum that would have been payable under this Contract, then the Contractor and the Surety will be liable and will pay to the Owner the amount of such excess. If the unpaid balance of the Contract Sum exceeds the cost of finishing the Work, including any and all additional costs and expenses to the Owner, such excess, to the extent earned, will be paid to the Contractor and/or Contractor's Surety.
- D. Upon termination of this Contract, the Owner has no liability for anticipated profits for unfinished Work.
- E. Termination of this Contract, or any portion thereof, will not relieve the Contractor or the Contractor's Surety of their liability for past and future damages, losses or claims on Work performed or on account of any act, omission, or breach by the Contractor. Liability for liquidated damages, if any, will continue to accrue as set forth in the Contract Documents.
- F. The Owner's right to termination, as set forth herein, shall be in addition to and not a limitation of any and all other rights and remedies available to the Owner, at law, in equity or under the terms of this Contract. If the Owner improperly terminates this Contract for cause, this termination for cause will be converted to and deemed to be a termination for convenience in accordance with the provisions of Paragraph 13.03. In such case, Contractor shall only be entitled to those rights and remedies expressly stated in Paragraph 13.03 and in no event shall Contractor be entitled to any damages or remedies for wrongful termination.
- G. Termination of this Contract, or portion thereof, under this Article does not relieve the Contractor or the Contractor's Surety of its responsibilities for the completed portion of the Work or its obligation for and concerning any just claims arising out of the Work performed.

13.02 SUSPENSION BY THE OWNER FOR CONVENIENCE

The Owner may, without cause, order the Contractor in writing to suspend, delay or interrupt the Work in whole or in part for such period of time as the Owner may determine. If the whole Work is suspended, all days elapsing due to causes not the fault of the Contractor between the effective dates of the Owner's order to suspend and subsequent order to resume the Work will be excluded from the Contract Time.

13.03 TERMINATION FOR CONVENIENCE OF OWNER

- A. Notwithstanding anything else in this Contract, the Owner may terminate performance of the Work under this Contract in whole or in part if the Owner determines that a termination is in the Owner's best interest or its sole and absolute discretion. The Owner will terminate by delivery to the Contractor a Notice of Termination specifying the extent of termination and the effective date.
- B. After receipt of a Notice of Termination, and except as directed by the Owner, the Contractor will immediately proceed with the following obligations, regardless of any delay in determining or adjusting any amounts due under this Paragraph:
 - 1. Complete Work not terminated and stop Work as specified in the Notice of Termination.
 - 2. Place no further subcontracts or orders (referred to as subcontracts in this paragraph) for materials, services, or facilities, except as necessary to complete the continued portion of the Contract.
 - 3. Terminate all subcontracts to the extent they related to the Work terminated.
 - 4. Assign to the Owner, as directed, all rights, title, and interest of the Contractor under the subcontract terminated, in which case the Owner will have the right to settle or to pay any termination settlement proposal arising out of those terminations.
 - 5. With approval or ratification to the extent required by the Owner, settle all outstanding liabilities and termination settlement proposals arising from the terminations of subcontracts (the approval or ratification will be final for purposes of this paragraph).
 - 6. As directed by the Owner, transfer title and deliver to the Owner (1) the fabricated or unfabricated parts, Work in progress, completed Work, supplies, and other material produced or acquired for the Work terminated, and (2) the completed or partially completed plans, drawings, information, and other property that, if the Contract had been completed, would be required to be furnished to the Owner.
 - 7. Complete performance of the Work not terminated. If it should become necessary to suspend Work for an indefinite period, the Contractor will store all materials in such a manner that they will not become an obstruction nor become damaged in any way. The Contractor will take every precaution to prevent damage or deterioration of the Work performed and provide for normal

drainage of the Work. The Contractor will erect temporary structures where necessary to provide for traffic on, to, or from the Airport.

8. Take any action that may be necessary, or that the Owner may direct, for the protection and preservation of the property related to this Contract that is in the possession of the Contractor and in which the Owner has or may acquire an interest.
 9. Use its best effort to sell, as directed or authorized by the Owner, any property of the types referred to in Subparagraph 13.03 B.6. above; provided, however, that the Contractor (1) is not required to extend credit to any purchaser and (2) may acquire the property under the conditions prescribed by, and at process approved by, the Owner. The proceeds of any transfer or disposition will be applied to reduce any payments to be made by the Owner under this Contract, credited to the price or cost of the Work, or paid in any manner directed by the Owner.
- C. The Contractor may submit to the Owner a list, certified as to quantity and quality, of termination inventory not previously disposed of, excluding items authorized for disposition by the Owner. Within 30 days, the Owner will accept title of those items and remove them or enter into a storage contract. The Owner may verify the list upon removal of the items or, if stored, within 45 days from submission of the list, and will correct the list, as necessary, before final settlement.
- D. After termination, the Contractor will submit a final termination settlement proposal to the Owner in the form and with the certification prescribed by the Owner. The Contractor will submit the proposal promptly, but no later than 60 days from the effective date of termination, unless extended in writing by the Owner upon written request of the Contractor. If the Contractor fails to submit the proposal within the time allowed, the Owner may determine, on the basis of information available, the amount, if any, due the Contractor because of the termination and will pay the amount determined. No further compensation will be considered if the Contractor fails to meet the submittal requirements.
1. Subject to Paragraph 13.03 D. above, the Contractor and the Owner may agree upon the whole or any part of the amount to be paid because of the termination. The amount may include a reasonable allowance for profit of Work done. However, the agreed amount may not exceed the total Contract sum as reduced by (1) the amount of payments previously made and (2) the Contract Sum of Work not terminated. The Contract will be amended and the Contractor paid the agreed amount. Paragraph 13.03 F. below will not limit, restrict, or affect the amount that may be agreed upon to be paid under this Paragraph.
- E. If the Contractor and the Owner fail to agree on the whole amount to be paid the Contractor because of termination of the Work, the Owner will pay the Contractor the amounts determined as follows, but without duplication of any amounts agreed upon under Paragraph 13.03 D.1. above:
1. For Contract Work performed before the effective date of termination, the total (without duplication of any items) of:
 - a. The cost of this Work;

- b. The cost of settling and paying termination settlement proposals under terminated subcontracts that are properly chargeable to the termination portion of the Contract if not included in subdivision a. above; and
 - c. A sum, as profit on a. above, which will not exceed 5%. If it appears, however, that the Contractor would have sustained a loss on the entire Contract had it been completed, the Owner will allow no profit under this subparagraph c. and will reduce the settlement to reflect the indicated rate of loss.
 - d. When the Contract, or any portion thereof, is terminated before completion of all items of Work in the Contract, payment will be made for the actual number of units of Work completed at the Bid Unit Price or as mutually agreed for items of Work partially completed. No claims or loss of anticipated profits will be considered for items of Work completed at the Bid Unit Prices.
- 2. The reasonable costs of settlement of the Work terminated, including:
 - a. Reasonable accounting, clerical, and other expenses necessary only for the preparation of termination settlement proposals and support data;
 - b. The termination and settlement of subcontracts (excluding the amounts of such settlements);
 - c. Storage, transportation, and other costs incurred, reasonably necessary for the preservation, protection, or disposition of the termination inventory; and
 - d. Reimbursement for organization of the Work and other overhead expenses (when not otherwise included in the Contract), and moving equipment and materials to and from the site will be considered..
- F. Except for normal spoilage, and except to the extent that the Owner expressly assumed the risk of loss, the Owner will exclude from the amounts payable to the Contractor under Paragraph 13.03 E. above, the fair value, as determined by the Owner, of property that is destroyed, lost, stolen, or damaged so as to become undeliverable to the Owner or to the buyer.
- G. In arriving at the amount due the Contractor under this paragraph, there will be deducted:
 - 1. All unliquidated advance or other payments to the Contractor under the terminated portion of the Contract;
 - 2. Any claim which the Owner has against the Contractor under this Contract;
 - 3. The agreed price for, or the proceeds of sale of, materials, supplies, or other things acquired by the Contractor or sold under the provisions of this paragraph and not recovered by or credited to the Owner; and
 - 4. Contractor expressly waives any claim for loss of anticipated profit, overhead of any kind, including home office and jobsite overhead, or other indirect impacts.

- H. Unless otherwise provided in this Contract or by statute, the Contractor will maintain all records and documents (including but not limited to subcontracts, subcontractor change orders, purchase orders, bid tabulations, proposals, and all other documents associated with the project) relating to the termination portion of this Contract for seven years after final settlement. This includes all books and other evidence bearing on the Contractor's costs and expenses under this Contract. The Contractor will make these records and documents available to the Owner, at the Contractor's office, at all reasonable times, without any direct charge. If approved by the Owner, photographs, microphotographs, electronic media or other authentic reproductions may be maintained instead of original records and documents.

PART 14 – AUDIT REQUIREMENTS

14.01 PAYMENTS

In connection with payments to the Contractor under this Contract, it is agreed the Contractor will maintain full, accurate and detailed books of account and records customarily used in this type of business operation in accordance with generally accepted accounting principles. The Owner, FAA, Federal Highway Administration, Florida Department of Transportation and the Comptroller General of the United States, or any duly authorized representative of each, may have the right to audit the Contractor's records for the purpose of making audits, examinations, excerpts, and/or transcriptions and to determine payment eligibility under this Contract and compliance with this Contract. The Owner also has the right to perform inspections or attestation engagements. Access will be to any and all of the Contractor's records, including books, documents, papers, accounting procedures and practices, and any other supporting evidence the Owner deems pertinent to this Contract, as well as records of parent, affiliate and subsidiary companies. The Contractor shall maintain such books and records for seven years after the end of the term of this Contract.

14.02 ACCESS TO RECORDS

If the records are kept at locations other than the Airport, Contractor will arrange for said records to be brought to a location convenient to Owner's auditors to conduct the engagement as set forth in this Article or Contractor may transport Owner's team to location of the records for purposes of undertaking said engagement. In such event, Contractor will pay reasonable costs of transportation, food and lodging for Owner's team.

14.03 RECORDS FORMAT

In the event the Contractor maintains its accounting or Project information in electronic format, upon request by the Owner's auditors, the Contractor will provide a download of its accounting or Project information in an electronic format allowing readership in Microsoft Office products or Adobe Acrobat software.

14.04 RECORDS DELIVERY

Contractor agrees to deliver or provide access to all records requested by Owner's auditors within 14 calendar days of the request at the initiation of the engagement and to deliver or provide access to subsequent requests during the engagement within 7 calendar days of each request. The parties recognize that the Owner will incur additional costs if records requested by Owner's auditors are not provided in a timely manner and that the amount of those costs is extremely difficult to determine with certainty. Consequently, the parties agree that Contractor may be assessed liquidated damages of \$100.00, in addition to other contractual financial requirements, for each item in a records request, per

calendar day, for each time Contractor is late in submitting requested records to perform the engagement. Accrual of fees will continue until specific performance is accomplished. The parties expressly agree that these liquidated damages are not a penalty and represent reasonable estimates of fair compensation for the losses that reasonably may be anticipated from such failure to comply.

14.05 ENGAGEMENT

The Owner has the right during any engagement to interview the Contractor's employees, subcontractors, subconsultants, suppliers or any other persons associated with the Work or this Contract, to make photocopies, and to inspect any and all records upon request. The right to initiate an engagement, inspection or attestation engagement will extend during the Contract period and for six years after the completion date of the Work, or six years after the termination of this Contract, whichever occurs later.

14.06 RECORDS RETENTION

The Contractor will provide all information and reports requested by the Owner, or any of their duly authorized representatives, or directives issued pursuant thereto, and will permit access, for the purpose of performing an audit, examination, inspection, or attestation engagement, to the Contractor's books, records, accounts, documents, papers, or other sources of information, and its facilities as may be determined by the Owner to be pertinent to ascertain compliance with this Article. The Contractor will keep all Project accounts and records which fully disclose the amount of the Contractor's Bid. The accounts and records will be kept in accordance with an accounting system that will facilitate an effective audit in accordance with the Single Audit Act of 1984, as amended.

14.07 OVERCHARGE PROVISIONS

In the event the Contractor has overcharged the Owner, the Contractor will re-pay the Owner the amount of the overcharge, plus interest on the overcharge amount up to 12% per year from the date the overcharge occurred. In addition, if the Contractor has overcharged the Owner by more than 3% of the correct reimbursable amount, the Owner may assess and the Contractor will pay for the entire cost of the audit.

14.08 SUBCONTRACT AUDIT PROVISIONS

The Contractor will include in all subcontractor, subconsultant and supplier contracts a provision which provides the Owner the same rights to audit as provided in this Article.

14.09 OWNER'S RIGHT TO AUDIT

Approvals by Owner's staff for any services not included in this Contract do not act as a waiver or limitation of the Owner's right to audit.

PART 15 – CIVIL RIGHTS

15.01 GENERAL REQUIREMENT FOR CONTRACTS

Subject to the applicability criteria noted in the specific Contract provisions, these Contract provisions apply to all work performed on the Contract. Failure to comply with the terms of these Contract provisions may be sufficient grounds to:

1. Withhold progress payments or final payment,

2. Terminate the Contract,
3. Seek suspension/debarment, or
4. Any other action determined to be appropriate by the Owner or the FAA.

15.02 CIVIL RIGHTS – GENERAL - 49 USC § 47123

- A. The Contractor agrees that it will comply with pertinent statutes, Executive Orders and such rules as are promulgated to ensure that no person shall, on the grounds of race, creed, color, national origin, sex, age, or handicap be excluded from participating in any activity conducted with or benefiting from Federal assistance.
- B. Duration:
 1. This provision binds the Contractor from the bid solicitation period through the completion of the Contract. This provision is in addition to that required of Title VI of the Civil Rights Act of 1964.
 2. This provision also obligates the Contractor or its transferee for the period during which Federal assistance is extended to the airport through the Airport Improvement Program, except where Federal assistance is to provide, or is in the form of personal property; real property or interest therein; structures or improvements thereon. In these cases the provision obligates the Contractor for the longer of the following periods:
 - i. The period during which the property is used by the Owner or any transferee for a purpose for which Federal assistance is extended, or for another purpose involving the provision of similar services or benefits; or
 - ii. The period during which the Owner or any transferee retains ownership or possession of the property.

END OF SECTION

SECTION 00820 – WOMAN AND MINORITY OWNED BUSINESS ENTERPRISE (W/MBE)

PART 1 - GENERAL

1.01 DESCRIPTION

- A. Woman and Minority Owned Business Enterprise (W/MBE) documents include:
1. Authority Non-Federally Funded Policy
 2. Certified W/MBE Directory
 3. W/MBE Application
 4. Personal Statement of Net Worth
- B. The above listed W/MBE documents are not included herein but can be obtained in Adobe Acrobat format by accessing the “Airport Business” section of the Owner’s website, www.tampaairport.com.

END OF SECTION

SECTION 00850 - DRAWING INDEX

DRAWING NUMBER	SHEET TITLE
GENERAL (G)	
G000	COVER AND INDEX OF DRAWINGS
G001	SUMMARY OF QUANTITIES
G002	SAFETY AND SECURITY NOTES AND DETAILS
G003	CONTRACT LAYOUT PLAN – PCA
G004	CONTRACT LAYOUT PLAN – POK
G005	GENERAL AND STAGING AREA NOTES
G006	OVERALL CONSTRUCTION PHASING NOTES AND SCHEMATIC
CIVIL (C)	
C101	FENCE PLAN – PCA AREA 1
C102	FENCE PLAN – PCA AREA 2 (SHEET 1 OF 2)
C103	FENCE PLAN – PCA AREA 2 (SHEET 2 OF 2)
C201	FENCE PLAN – POK AREA 1 (SHEET 1 OF 4)
C202	FENCE PLAN – POK AREA 1 (SHEET 2 OF 4)
C203	FENCE PLAN – POK AREA 1 (SHEET 3 OF 4)
C204	FENCE PLAN – POK AREA 1 (SHEET 4 OF 4)
C205	FENCE PLAN – POK AREA 2 AND 3
C301	FENCE DETAILS (SHEET 1 OF 2)
C302	FENCE DETAILS (SHEET 2 OF 2)

END OF SECTION